



## Beijing Xinfafa Group Welding Division

 Room 8729, 7th Floor, Building 2, No. 22, Yinghai Section,  
104 National Road, Daxing District, Beijing, China

 008618810788819

 john@xinfatools.com

 www.xinfatools.com



# XINFafa

## Welding & Cutting

# CONTENTS

## MIG/MAG/CO<sub>2</sub> Torches

1-34

### Compatible for

15AK .....	1
24KD .....	3
25AK .....	5
36KD .....	7
40KD .....	9
501D .....	11
602 .....	13
Automatic Welding Torches .....	15
Euro Handles Styles .....	16
200A .....	17
350A .....	19
500A .....	21
KH600A .....	23
Japanese Handles Styles .....	25
Lincoln1 .....	26
Lincoln2 .....	28
Lincoln3 .....	30
PSF 250/305/405/505 .....	31
Robot Welding Torches .....	33
Cleaning Torch Working Station .....	34

## Tig Torches

35-38

WP-9/WP-17/WP-18/WP-26/QQ-150A/QQ-300A/7 Type/AT-420(420S) .....	35
--	----

## Plasma Cutting Torches

39-41

P-80/PT-31/A-81/CB-50/LT-50/SP-60/TongChang60 .....	39
---	----

## Stud Welding Torches

42

LZHQ-01、LZHQ-02、LZHQ-03、LZHQ-04、LZHQ-05 .....	42
---	----

## Other Torches

43-44

## Accessories

45-48

### Compatible for

Fronius /OTC/Miller/Kemppi .....	45
----------------------------------	----

## Optional Central Connectors

49

### Compatible for

Panasonic/Binzel/OTC/Lincoln/Miller/PSF/Kemppi .....	49
--	----

## Other Accessories

50-61

Wire Feeder Genuine Parts .....	50
Wire Rollers/Liners/Plugs And Sockets .....	52
Other Accessories .....	61

## Car Special Spot Welding Electrode And Accessories

62

Compatible Torch and Parts For BINZEL  
**15AK Air Cooled MIG/MAG Welding Torch**

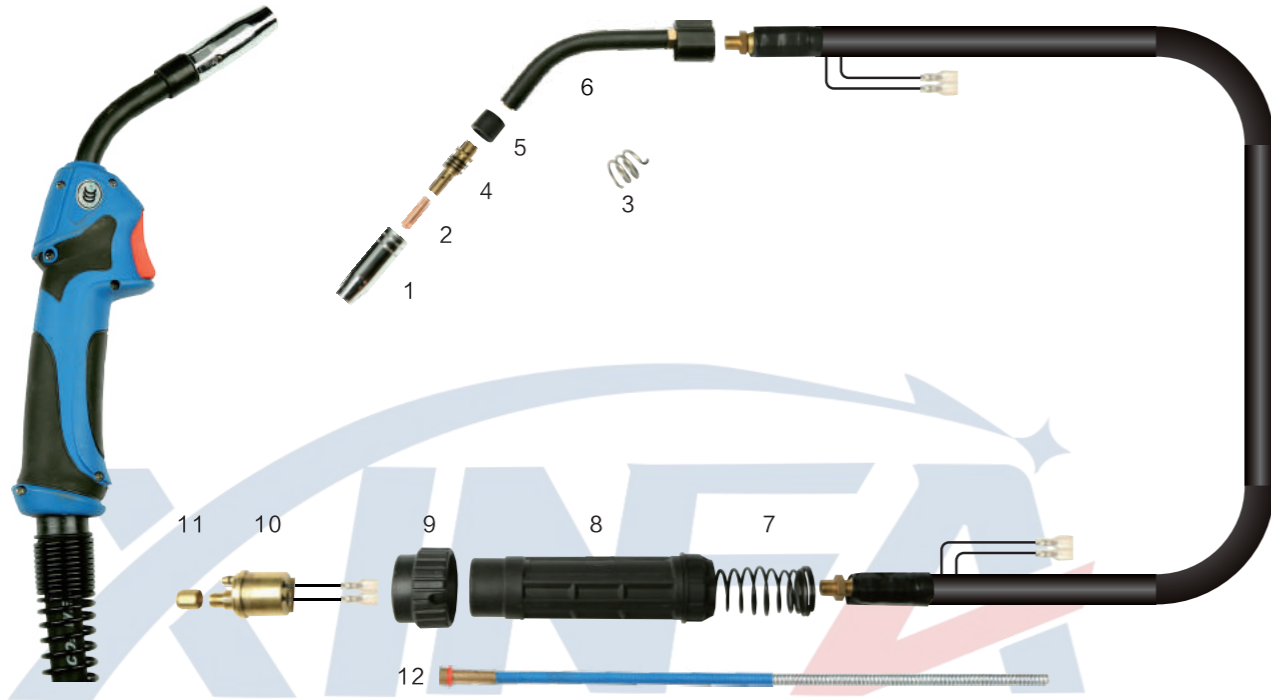

**Technical Data**

Rating : 180A CO2  
 150A Mixed Gases  
 Duty cycle : 60%  
 Wire size : 0.6-1.0mm

No.	Description
	15AK Complete Torch 3M
	15AK Complete Torch 5M
1	Cylindrical Nozzle $\phi$ 16mm
	Conical Nozzle $\phi$ 12mm
	Tapered Nozzle $\phi$ 9.5mm
2	M6*25*0.6 Contact Tip,E-Cu
	M6*25*0.8 Contact Tip,E-Cu
	M6*25*0.9 Contact Tip,E-Cu
	M6*25*1.0 Contact Tip,E-Cu
	M6*25*0.6 Contact Tip,CuCrZr
	M6*25*0.8 Contact Tip,CuCrZr
	M6*25*1.0 Contact Tip,CuCrZr
3	Contact Tip Holder Spring

No.	Description
4	Contact Tip Holder
5	Insulator
6	Swan Neck
7	Cable Support Spring
8	Rear Handle
9	Adaptor Nut
10	Euro Connector
11	Nut M10*1
12	Liner,For Wire $\phi$ 0.8-1.0,3.5M
	Liner,For Wire $\phi$ 0.8-1.0,5.5M

**Wear Parts**

$\phi$ A	Description
$\phi$ 16	Cylindrical Nozzle
$\phi$ 12	Conical Nozzle
$\phi$ 9.5	Tapered Nozzle

Description
M6*25*0.6 Contact Tip,E-Cu
M6*25*0.8 Contact Tip,E-Cu
M6*25*0.9 Contact Tip,E-Cu
M6*25*1.0 Contact Tip,E-Cu
M6*25*0.6 Contact Tip,CuCrZr
M6*25*0.8 Contact Tip,CuCrZr
M6*25*1.0 Contact Tip,CuCrZr

Description
Contact Tip Holder

Description
Swan Neck

Compatible Torch and Parts For BINZEL  
**24KD Air Cooled MIG/MAG Welding Torch**

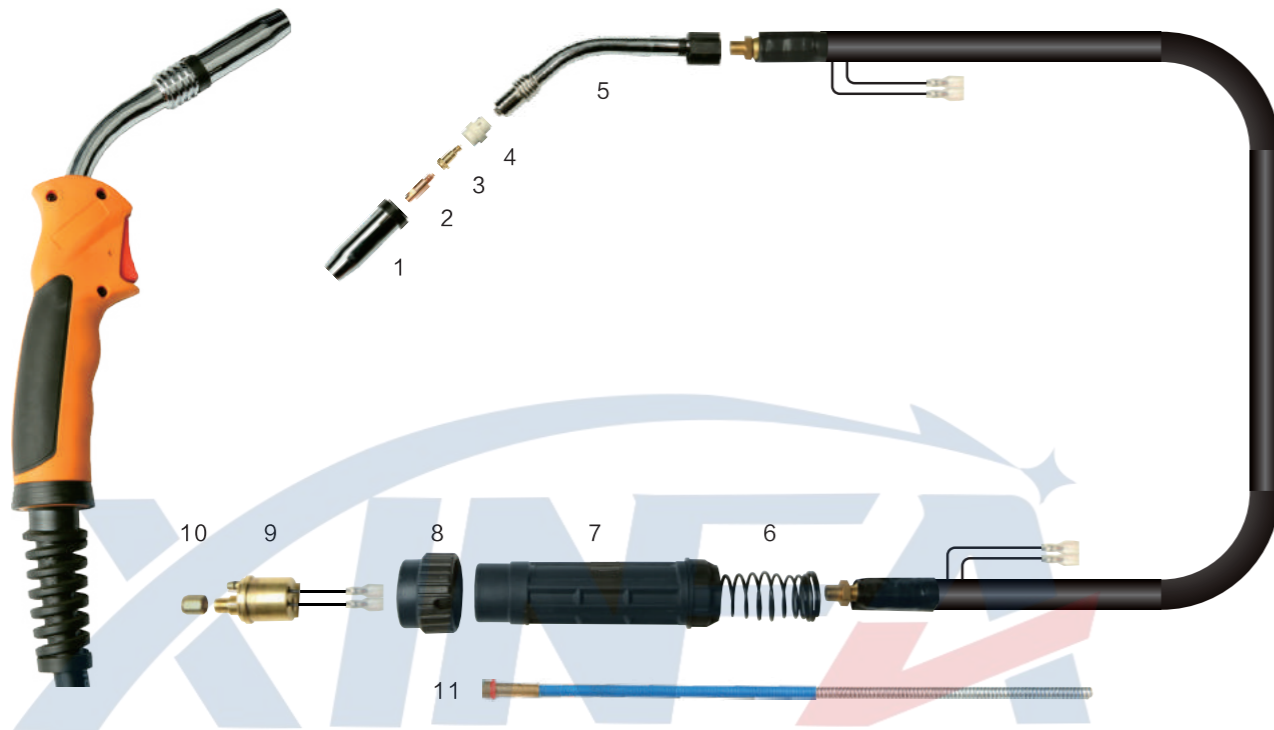

**Technical Data**

Rating : 250A CO2  
 220A Mixed Gases  
 Duty cycle : 60%  
 Wire size : 0.8-1.2mm

No.	Description
	24KD Complete Torch 3M
	24KD Complete Torch 5M
1	Cylindrical Nozzle $\phi$ 17mm
	Conical Nozzle $\phi$ 12.5mm
	Tapered Nozzle $\phi$ 10mm
2	M6*28*0.8 Contact Tip,E-Cu
	M6*28*0.9 Contact Tip,E-Cu
	M6*28*1.0 Contact Tip,E-Cu
	M6*28*1.2 Contact Tip,E-Cu
	M6*28*0.8 Contact Tip,CuCrZr
	M6*28*1.0 Contact Tip,CuCrZr
	M6*28*1.2 Contact Tip,CuCrZr
3	Contact Tip Holder

No.	Description
4	Gas Diffuser
5	Swan Neck
6	Cable Support Spring
7	Rear Handle
8	Adaptor Nut
9	Euro Connector
10	Nut M10*1
11	Liner,For Wire $\phi$ 0.8-1.2,3.5M
	Liner,For Wire $\phi$ 0.8-1.2,5.5M

**Wear Parts**

$\phi$ A	Description
$\phi$ 17	Cylindrical Nozzle
$\phi$ 12.5	Conical Nozzle
$\phi$ 10	Tapered Nozzle

Description
M6*28*0.8 Contact Tip,E-Cu
M6*28*0.9 Contact Tip,E-Cu
M6*28*1.0 Contact Tip,E-Cu
M6*28*1.2 Contact Tip,E-Cu
M6*28*0.8 Contact Tip,CuCrZr
M6*28*1.0 Contact Tip,CuCrZr
M6*28*1.2 Contact Tip,CuCrZr

Description
Contact Tip Holder

Description
Gas Diffuser, DMC
Gas Diffuser, Ceramic

Description
Swan Neck

Compatible Torch and Parts For BINZEL  
**25AK Air Cooled MIG/MAG Welding Torch**

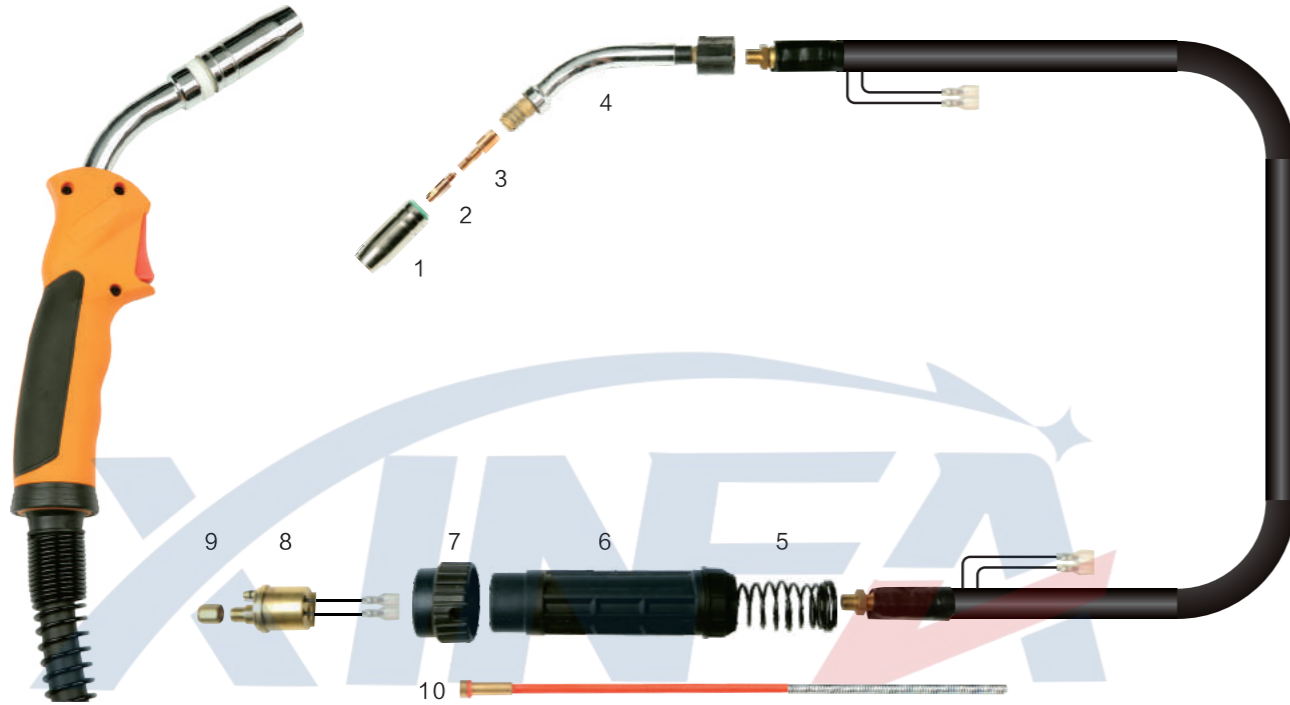

**Technical Data**

Rating : 230A CO<sub>2</sub>  
 200A Mixed Gases  
 Duty cycle : 60%  
 Wire size : 0.8-1.2mm

No.	Description
	25AK Complete Torch 3M
	25AK Complete Torch 5M
1	Cylindrical Nozzle $\phi$ 18mm
	Conical Nozzle $\phi$ 15mm
	Tapered Nozzle $\phi$ 11.5mm
2	M6*28*0.8 Contact Tip,E-Cu
	M6*28*0.9 Contact Tip,E-Cu
	M6*28*1.0 Contact Tip,E-Cu
	M6*28*1.2 Contact Tip,E-Cu
	M6*28*0.8 Contact Tip,CuCrZr
	M6*28*1.0 Contact Tip,CuCrZr
	M6*28*1.2 Contact Tip,CuCrZr
3	Contact Tip Holder

No.	Description
4	Swan Neck
5	Cable Support Spring
6	Rear Handle
7	Adaptor Nut
8	Euro Connector
9	M10*1Nut M10*1
10	Liner,For Wire $\phi$ 0.8-1.0,3.5M
	Liner,For Wire $\phi$ 0.8-1.0,5.5M

**Wear Parts**

$\phi$ A	Description
$\phi$ 18	Cylindrical Nozzle, Wall Thickness 2.0
$\phi$ 15	Conical Nozzle,Wall Thickness 2.0
$\phi$ 11.5	Tapered Nozzle,Wall Thickness 2.0
$\phi$ 19	Cylindrical Nozzle, Wall Thickness 1.5
$\phi$ 15	Conical Nozzle,Wall Thickness 1,5
$\phi$ 11.5	Tapered Nozzle,Wall Thickness 1.5

Description
M6*28*0.8 Contact Tip,E-Cu
M6*28*0.9 Contact Tip,E-Cu
M6*28*1.0 Contact Tip,E-Cu
M6*28*1.2 Contact Tip,E-Cu
M6*28*0.8 Contact Tip,CuCrZr
M6*28*1.0 Contact Tip,CuCrZr
M6*28*1.2 Contact Tip,CuCrZr

Description
Contact Tip Holder

Description
Swan Neck

Compatible Torch and Parts For BINZEL  
**36KD Air Cooled MIG/MAG Welding Torch**

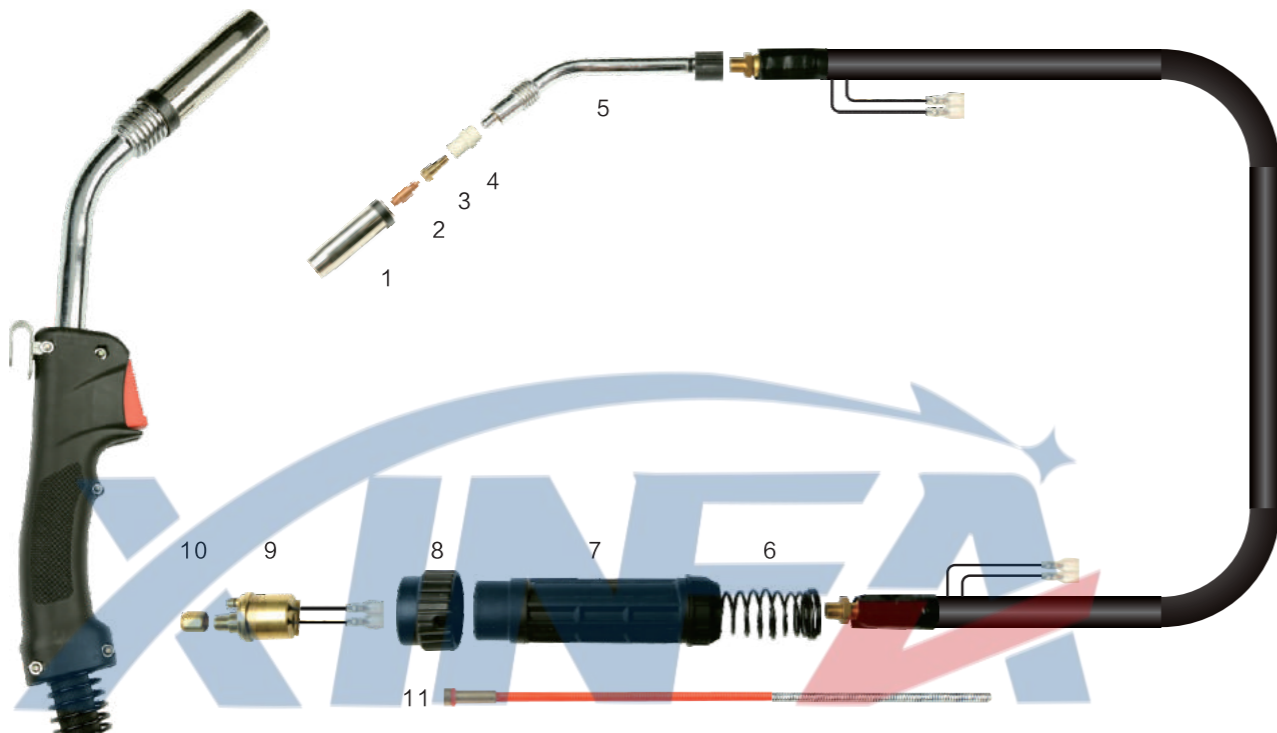

**Technical Data**

Rating : 340A CO2  
 320A Mixed Gases  
 Duty cycle : 60%  
 Wire size : 0.8-1.2mm

No.	Description
	36KD Complete Torch 3M
	36KD Complete Torch 5M
1	Cylindrical Nozzle $\phi$ 19mm
	Conical Nozzle $\phi$ 16mm
	Tapered Nozzle $\phi$ 12mm
2	M8*30*0.8 Contact Tip,E-Cu
	M8*30*1.0 Contact Tip,E-Cu
	M8*30*1.2 Contact Tip,E-Cu
	M8*30*0.8 Contact Tip,CuCrZr
	M8*30*1.0 Contact Tip,CuCrZr
	M8*30*1.2 Contact Tip,CuCrZr
3	Contact Tip Holder,M8*25
	Contact Tip Holder,M8*28

No.	Description
	Contact Tip Holder,M8*34
4	Gas Diffuser
5	Swan Neck
6	Cable Support Spring
7	Rear Handle
8	Adaptor Nut
9	Euro Connector
10	Nut M10*1
11	Liner,For Wire $\phi$ 0.8-1.2,3.5M
	Liner,For Wire $\phi$ 0.8-1.2,5.5M

**Wear Parts**

Description
Cylindrical Nozzle
Conical Nozzle
Tapered Nozzle

Description
M8*30*0.8 Contact Tip,E-Cu
M8*30*1.0 Contact Tip,E-Cu
M8*30*1.2 Contact Tip,E-Cu
M8*30*0.8 Contact Tip,CuCrZr
M8*30*1.0 Contact Tip,CuCrZr
M8*30*1.2 Contact Tip,CuCrZr

Description
Contact Tip Holder,M8*25
Contact Tip Holder,M8*28
Contact Tip Holder,M8*34

Description
Gas Diffuser, DMC
Gas Diffuser, Ceramic

Description
Swan Neck

Compatible Torch and Parts For BINZEL  
**40KD Air Cooled MIG/MAG Welding Torch**

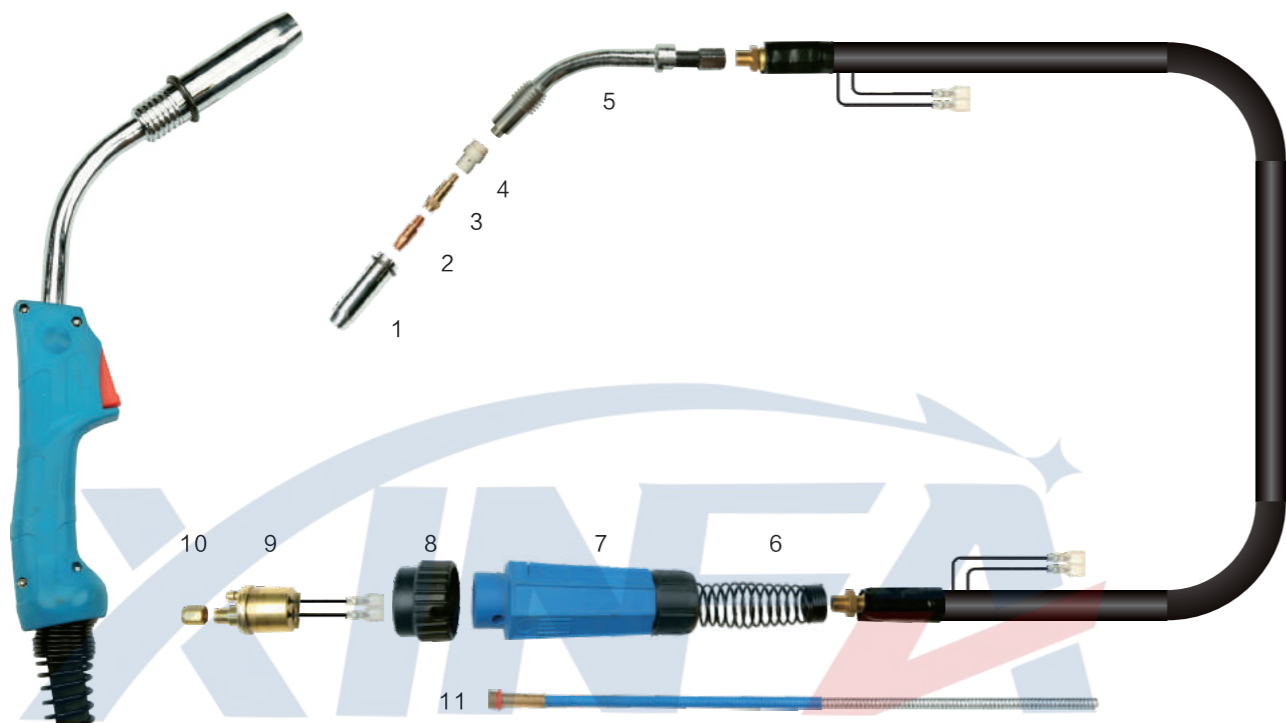

**Technical Data**

Rating : 380A CO2  
 360A Mixed Gases  
 Duty cycle : 60%  
 Wire size : 1.0-2.4mm

No.	Description
	40KD Complete Torch 3M
	40KD Complete Torch 5M
1	Cylindrical Nozzle $\phi$ 21mm
	Conical Nozzle $\phi$ 18mm
	Tapered Nozzle $\phi$ 14mm
2	M8*30*1.0 Contact Tip,E-Cu
	M8*30*1.2 Contact Tip,E-Cu
	M8*30*1.6 Contact Tip,E-Cu
	M8*30*1.0 Contact Tip,CuCrZr
	M8*30*1.2 Contact Tip,CuCrZr
	M8*30*1.6 Contact Tip,CuCrZr
	M8*30*2.0 Contact Tip,CuCrZr
	M8*30*2.4 Contact Tip,CuCrZr

No.	Description
3	Contact Tip Holder,M8*43
4	Gas Diffuser
5	Swan Neck
6	Cable Support Spring
7	Rear Handle
8	Adaptor Nut
9	Euro Connector
10	Nut M10*1
11	Liner,For Wire $\phi$ 1.2-1.6,3.5M
	Liner,For Wire $\phi$ 1.2-1.6,5.5M

**Wear Parts**



$\phi$ A	Description
$\phi$ 21	Cylindrical Nozzle
$\phi$ 18	Conical Nozzle
$\phi$ 14	Tapered Nozzle



Description
M8*30*1.0 Contact Tip,E-Cu
M8*30*1.2 Contact Tip,E-Cu
M8*30*1.6 Contact Tip,E-Cu
M8*30*1.0 Contact Tip,CuCrZr
M8*30*1.2 Contact Tip,CuCrZr
M8*30*1.6 Contact Tip,CuCrZr
M8*30*2.0 Contact Tip,CuCrZr
M8*30*2.4 Contact Tip,CuCrZr



Description
Contact Tip Holder,M8*43



Description
Gas Diffuser, DMC
Gas Diffuser, Ceramic



Description
Swan Neck

Compatible Torch and Parts For BINZEL

## 501D Water Cooled MIG/MAG Welding Torch

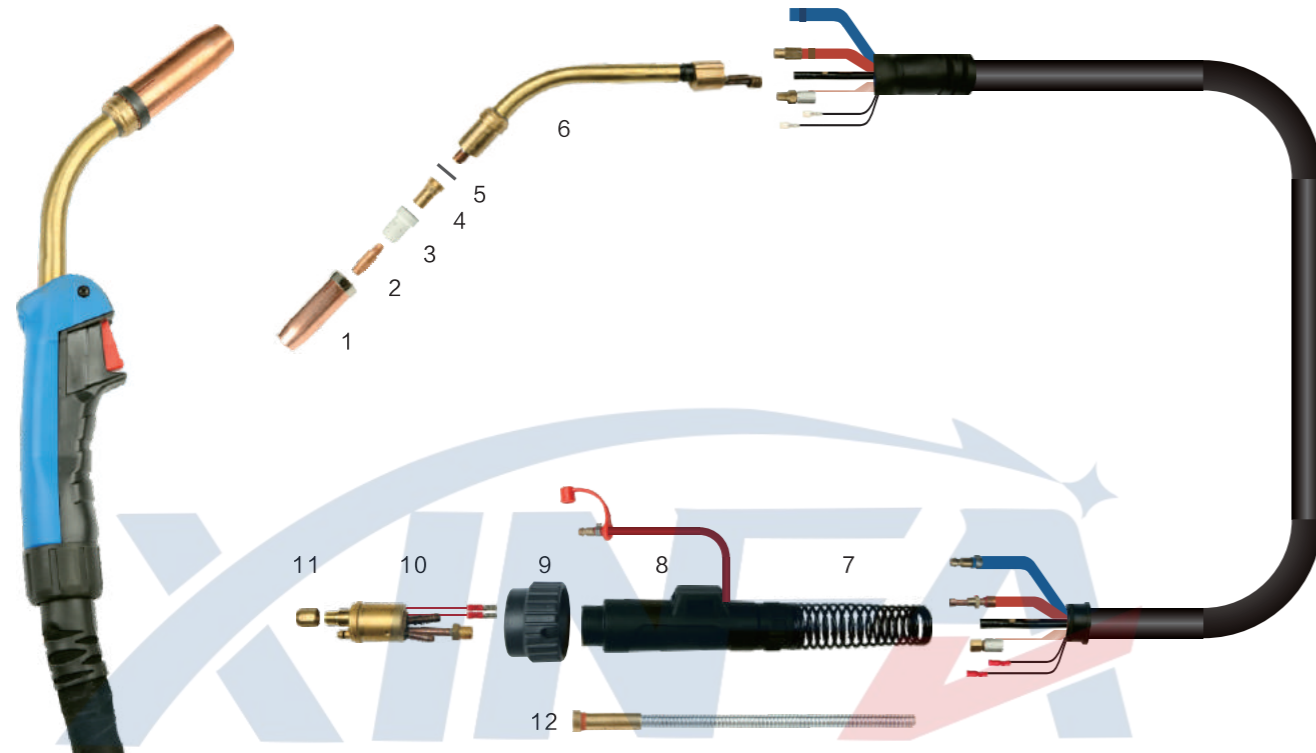

### Technical Data

Rating : 500A CO2  
450A Mixed Gases  
Duty cycle : 100%  
Wire size : 1.0-2.4mm

No.	Description
	501D Complete Torch 3M
	501D Complete Torch 5M
1	Cylindrical Nozzle $\phi$ 19mm
	Conical Nozzle $\phi$ 16mm
	Tapered Nozzle $\phi$ 14mm
2	M8*30*1.0 Contact Tip,E-Cu
	M8*30*1.2 Contact Tip,E-Cu
	M8*30*1.6 Contact Tip,E-Cu
	M8*30*1.0 Contact Tip,CuCrZr
	M8*30*1.2 Contact Tip,CuCrZr
	M8*30*1.6 Contact Tip,CuCrZr
	M8*30*2.4 Contact Tip,CuCrZr
3	Gas Diffuser

No.	Description
4	Contact Tip Holder,M8*25
	Contact Tip Holder,M8*29
5	Insulator
6	Swan Neck
7	Cable Support Spring
8	Rear Handle
9	Adaptor Nut
10	Central Connector WZ-2
11	Nut M10*1
12	Liner,For Wire $\phi$ 1.0-1.2,3.5M
	Liner,For Wire $\phi$ 1.0-1.2,5.5M

### Wear Parts

$\phi$ A	Description
$\phi$ 20	Cylindrical Nozzle, Wall Thickness 2.0
$\phi$ 16	Conical Nozzle,Wall Thickness 2.0
$\phi$ 14	Tapered Nozzle,Wall Thickness 2.0
$\phi$ 19	Cylindrical Nozzle, Wall Thickness 2.5
$\phi$ 16	Conical Nozzle,Wall Thickness 2.5
$\phi$ 14	Tapered Nozzle,Wall Thickness 2.5

Description
M8*30*1.0 Contact Tip,E-Cu
M8*30*1.2 Contact Tip,E-Cu
M8*30*1.6 Contact Tip,E-Cu
M8*30*1.0 Contact Tip,CuCrZr
M8*30*1.2 Contact Tip,CuCrZr
M8*30*1.6 Contact Tip,CuCrZr
M8*30*2.4 Contact Tip,CuCrZr

Description
Contact Tip Holder,M8*25
Contact Tip Holder,M8*29

Description
Gas Diffuser, DMC
Gas Diffuser, Ceramic

Description
Swan Neck



Compatible Torch and Parts For BINZEL  
**602 Water Cooled MIG/MAG Welding Torch**

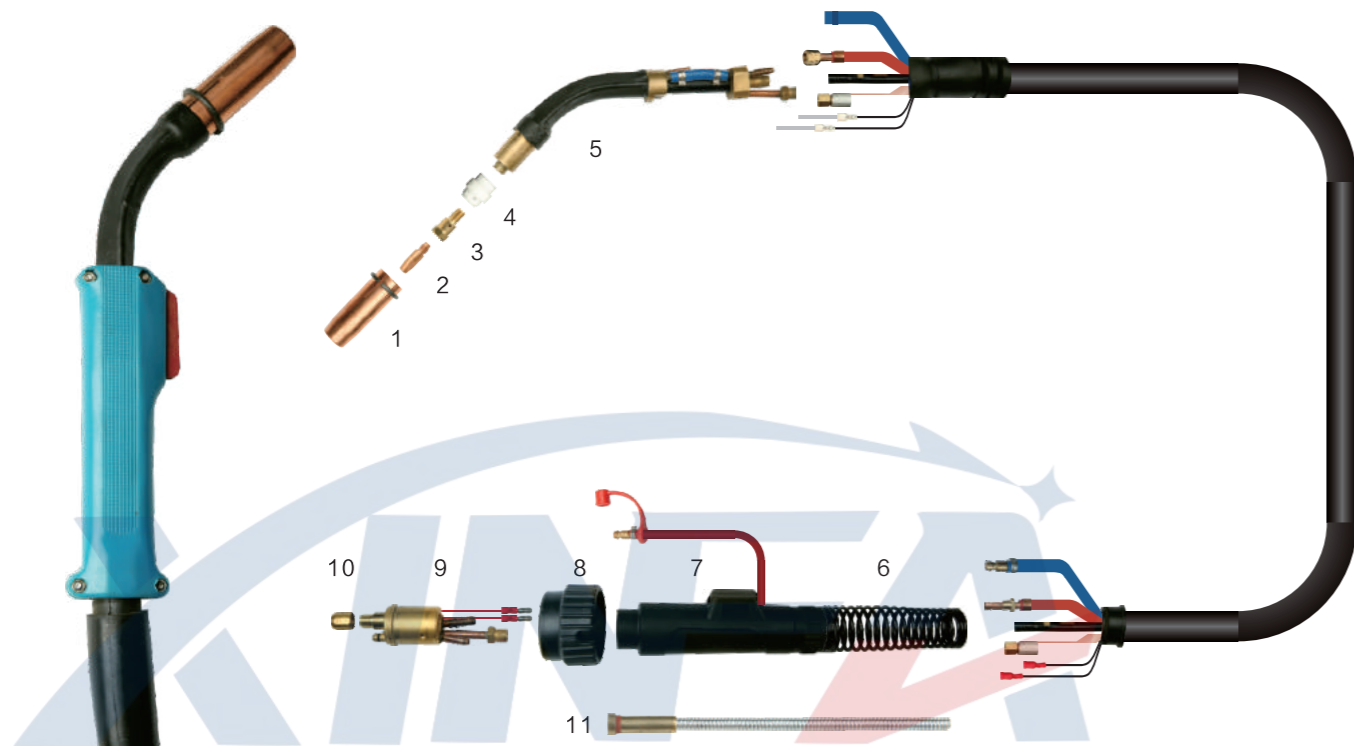

**Technical Data**

Rating : 600A CO2  
 550A Mixed Gases  
 Duty cycle : 100%  
 Wire size : 1.0-2.4mm

No.	Description
	602 Complete Torch 3M
	602 Complete Torch 5M
1	Nozzle $\phi$ 18mm
2	M8*30*1.0 Contact Tip,E-Cu
	M8*30*1.2 Contact Tip,E-Cu
	M8*30*1.6 Contact Tip,E-Cu
	M8*30*1.0 Contact Tip,CuCrZr
	M8*30*1.2 Contact Tip,CuCrZr
	M8*30*1.6 Contact Tip,CuCrZr
	M8*30*2.4 Contact Tip,CuCrZr
3	Contact Tip Holder,M8*25.5
4	Gas Diffuser
5	Swan Neck

No.	Description
6	Cable Support Spring
7	Rear Handle
8	Adaptor Nut
9	Central Connector
10	Nut M10*1
11	Liner,For Wire $\phi$ 1.2-1.6,3.5M
	Liner,For Wire $\phi$ 1.2-1.6,5.5M

**Wear Parts**

Description
Nozzle, $\phi$ 18

Description
M8*30*1.0 Contact Tip,E-Cu
M8*30*1.2 Contact Tip,E-Cu
M8*30*1.6 Contact Tip,E-Cu
M8*30*1.0 Contact Tip,CuCrZr
M8*30*1.2 Contact Tip,CuCrZr
M8*30*1.6 Contact Tip,CuCrZr
M8*30*2.4 Contact Tip,CuCrZr

Description
Contact Tip Holder,M8*25.5

Description
Gas Diffuser, DMC
Gas Diffuser, Ceramic

Description
Swan Neck

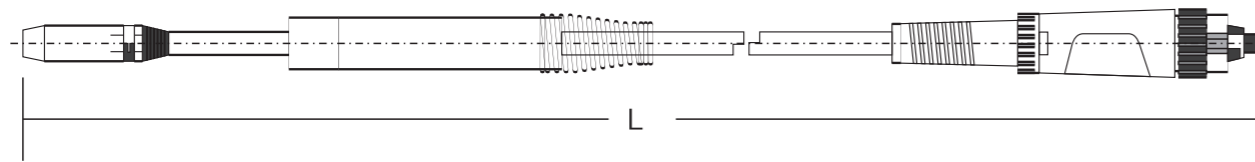
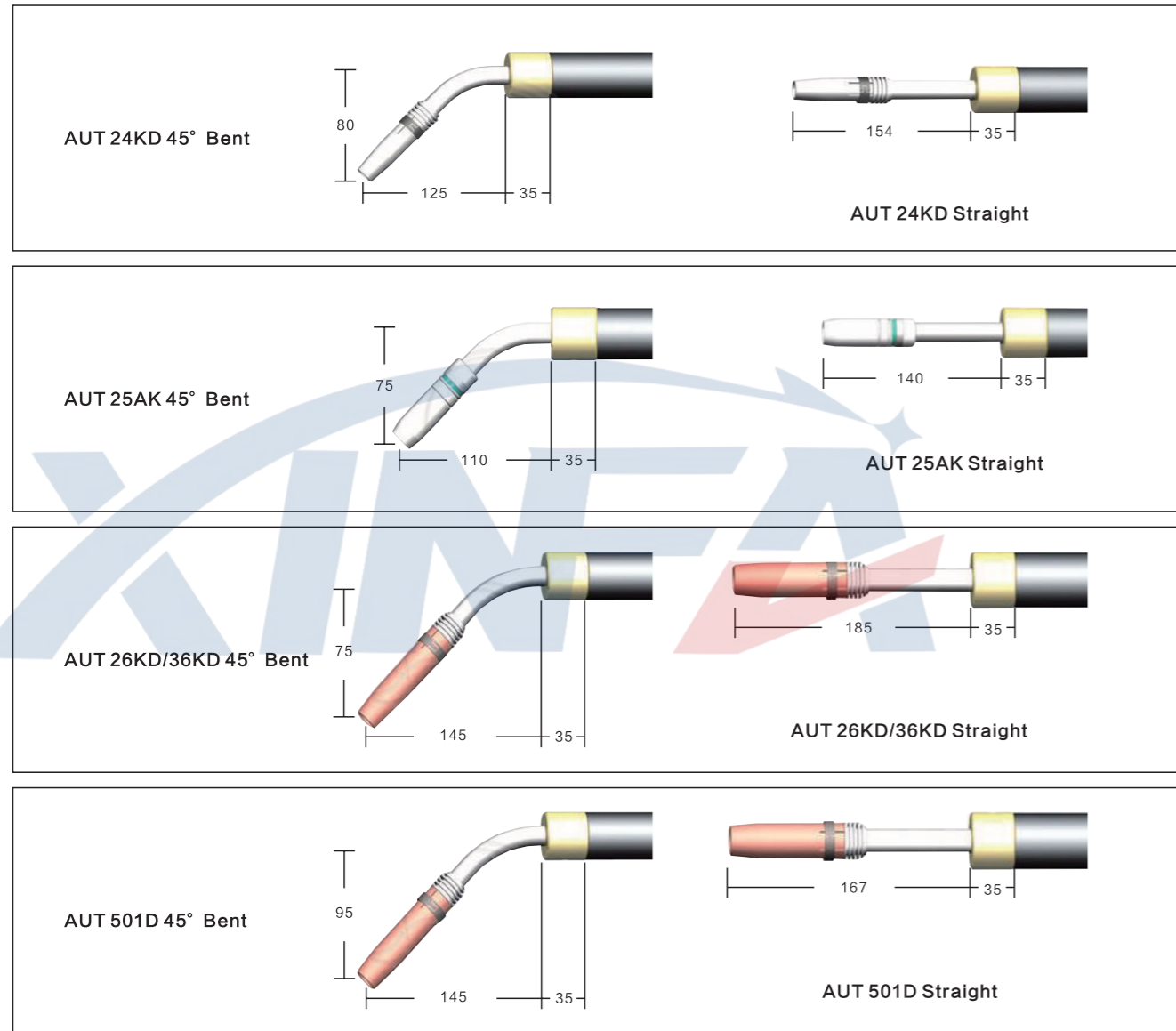

Please indicate torches type,torch geometry(Straight or 45° Bent)and length when ordering the complete torch  
The consumables-contact tip,gas nozzle,gas diffuser,contact tip holder and liner are identical with those of manual welding torches of same size

## Euro Handles Styles

Our welding torches can adapt to various form handles,you are being able to make one's option according to self need



Used For Binzel

Used For TBI

## Compatible Torch and Parts For Panasonic 200A Air Cooled MIG/MAG Welding Torch

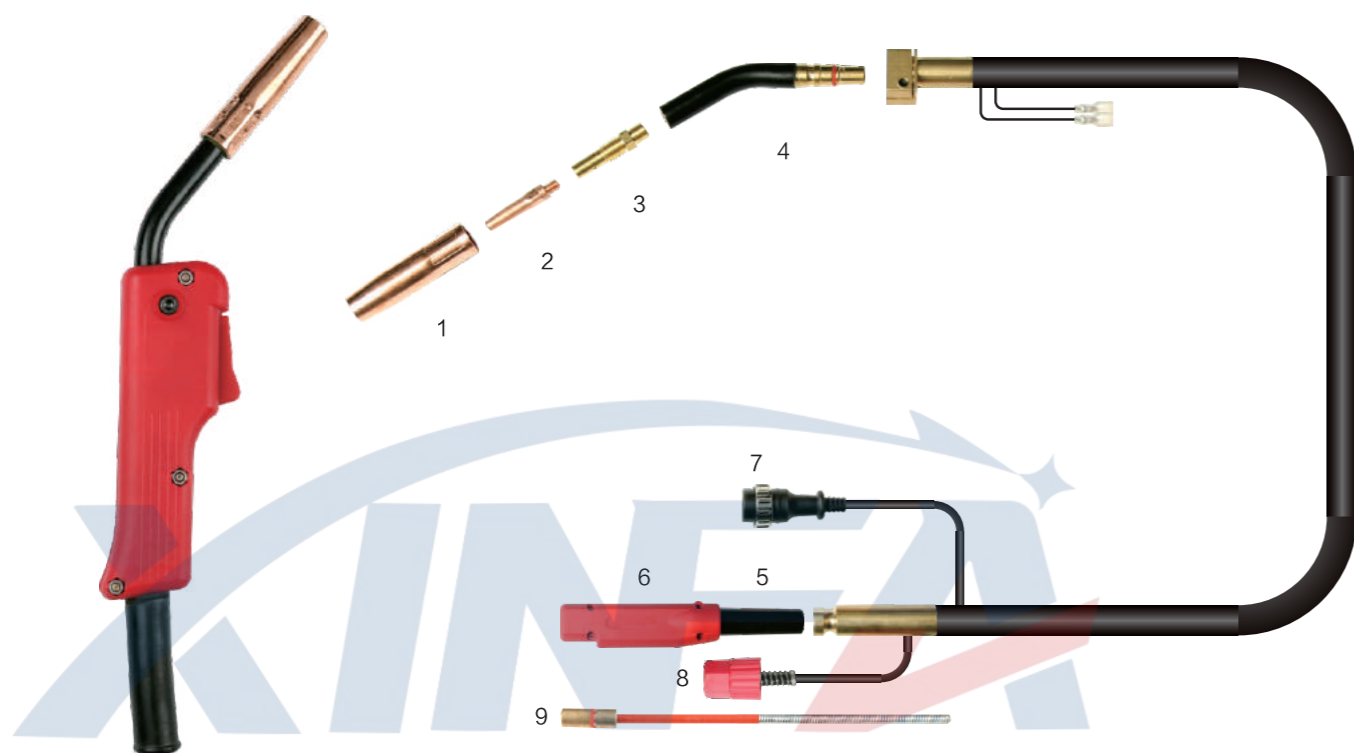

### Technical Data

Rating : 200A CO<sub>2</sub>  
160A Mixed Gases  
Duty cycle : 60%  
Wire size : 0.8-1.2mm

No.	Description
	200A Complete Torch 3M
	200A Complete Torch 5M
1	Nozzle $\phi$ 13mm
2	M6*45*0.8 Contact Tip,E-Cu
	M6*45*0.9 Contact Tip,E-Cu
	M6*45*1.0 Contact Tip,E-Cu
	M6*45*1.2 Contact Tip,E-Cu
	M6*45*0.8 Contact Tip,CuCrZr
	M6*45*0.9 Contact Tip,CuCrZr
	M6*45*1.0 Contact Tip,CuCrZr
	M6*45*1.2 Contact Tip,CuCrZr
3	Contact Tip Holder
4	Swan Neck Separable

No.	Description
5	Black Cable Support Rubber
6	Rear Handle
7	Control Lead Plug
8	Nut 9/16-18 UNF
9	Liner,For Wire $\phi$ 0.8-1.0,3.5M
	Liner,For Wire $\phi$ 0.8-1.0,5.5M

### Wear Parts

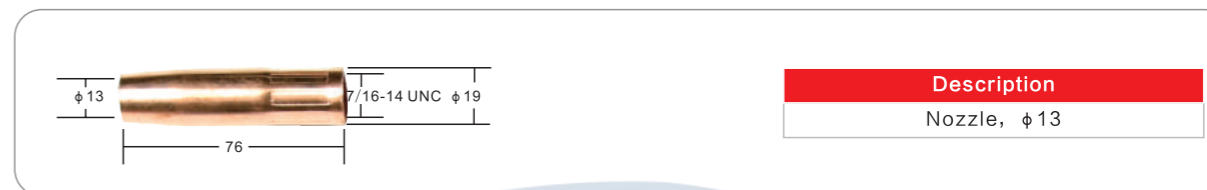

Description  
Nozzle,  $\phi$  13



Description  
M6\*45\*0.8 Contact Tip,E-Cu  
M6\*45\*0.9 Contact Tip,E-Cu  
M6\*45\*1.0 Contact Tip,E-Cu  
M6\*45\*1.2 Contact Tip,E-Cu  
M6\*45\*0.8 Contact Tip,CuCrZr  
M6\*45\*0.9 Contact Tip,CuCrZr  
M6\*45\*1.0 Contact Tip,CuCrZr  
M6\*45\*1.2 Contact Tip,CuCrZr

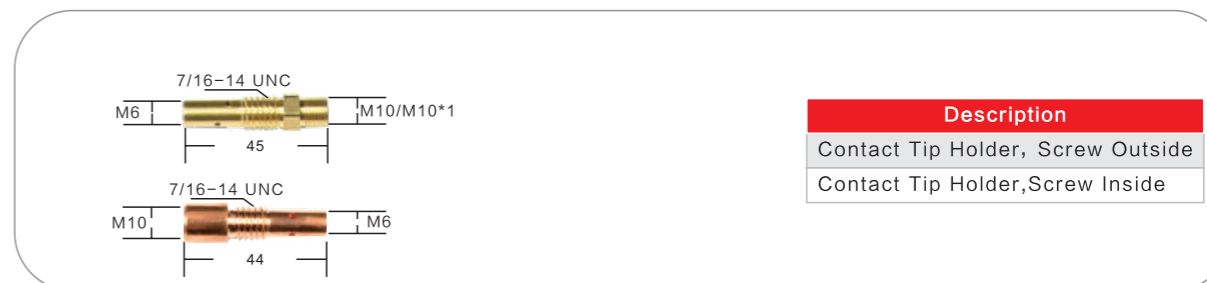

Description  
Contact Tip Holder, Screw Outside  
Contact Tip Holder,Screw Inside

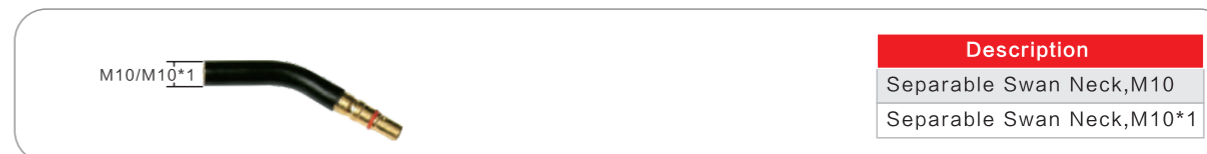

Description  
Separable Swan Neck,M10  
Separable Swan Neck,M10\*1

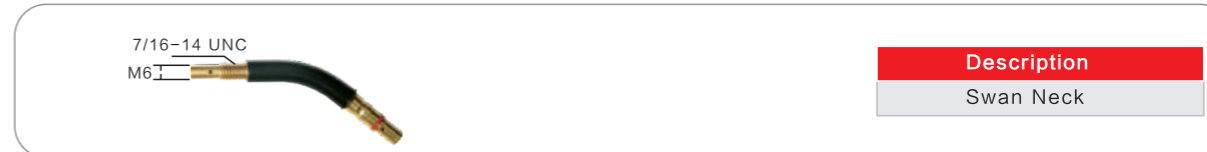

Description  
Swan Neck

## Compatible Torch and Parts For Panasonic 350A Air Cooled MIG/MAG Welding Torch

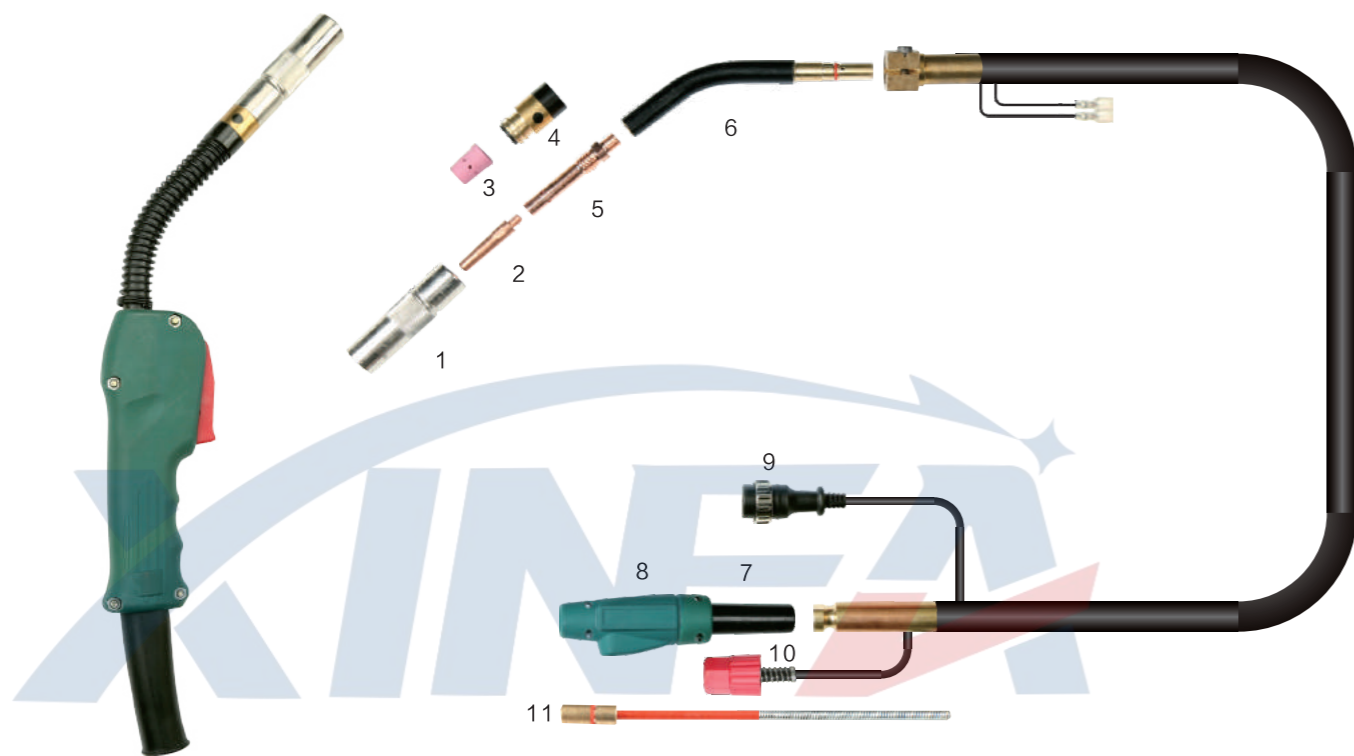

### Technical Data

Rating : 350A CO2  
300A Mixed Gases  
Duty cycle : 60%  
Wire size : 0.9-1.2mm

No.	Description
	350A Complete Torch 3M
	350A Complete Torch 5M
1	Cylindrical Nozzle $\phi$ 15mm
	Conical Nozzle $\phi$ 11.5mm
2	M6*45*0.9 Contact Tip,E-Cu
	M6*45*1.0 Contact Tip,E-Cu
	M6*45*1.2 Contact Tip,E-Cu
	M6*45*0.9 Contact Tip,CuCrZr
	M6*45*1.0 Contact Tip,CuCrZr
	M6*45*1.2 Contact Tip,CuCrZr
3	Gas Diffuser
4	Insulator
5	Contact Tip Holder

No.	Description
6	Swan Neck Separable
7	Black Cable Support Rubber
8	Rear Handle
9	Control Lead Plug
10	Nut 9/16-18 UNF
11	Liner,For Wire $\phi$ 1.0-1.2,3.5M
	Liner,For Wire $\phi$ 1.0-1.2,5.5M

### Wear Parts

$\phi$ A	Description
$\phi$ 16	Cylindrical Nozzle
$\phi$ 12	Conical Nozzle

Description
M6*45*0.9 Contact Tip,E-Cu
M6*45*1.0 Contact Tip,E-Cu
M6*45*1.2 Contact Tip,E-Cu
M6*45*0.9 Contact Tip,CuCrZr
M6*45*1.0 Contact Tip,CuCrZr
M6*45*1.2 Contact Tip,CuCrZr

Description
Gas Diffuser, Ceramic

Description
Insulator, Black
Insulator, Yellow

Description
Contact Tip Holder, Screw Outside
Contact Tip Holder,Screw Inside

  

Description
Separable Swan Neck

Description
Swan Neck

## Compatible Torch and Parts For Panasonic 500A Air Cooled MIG/MAG Welding Torch

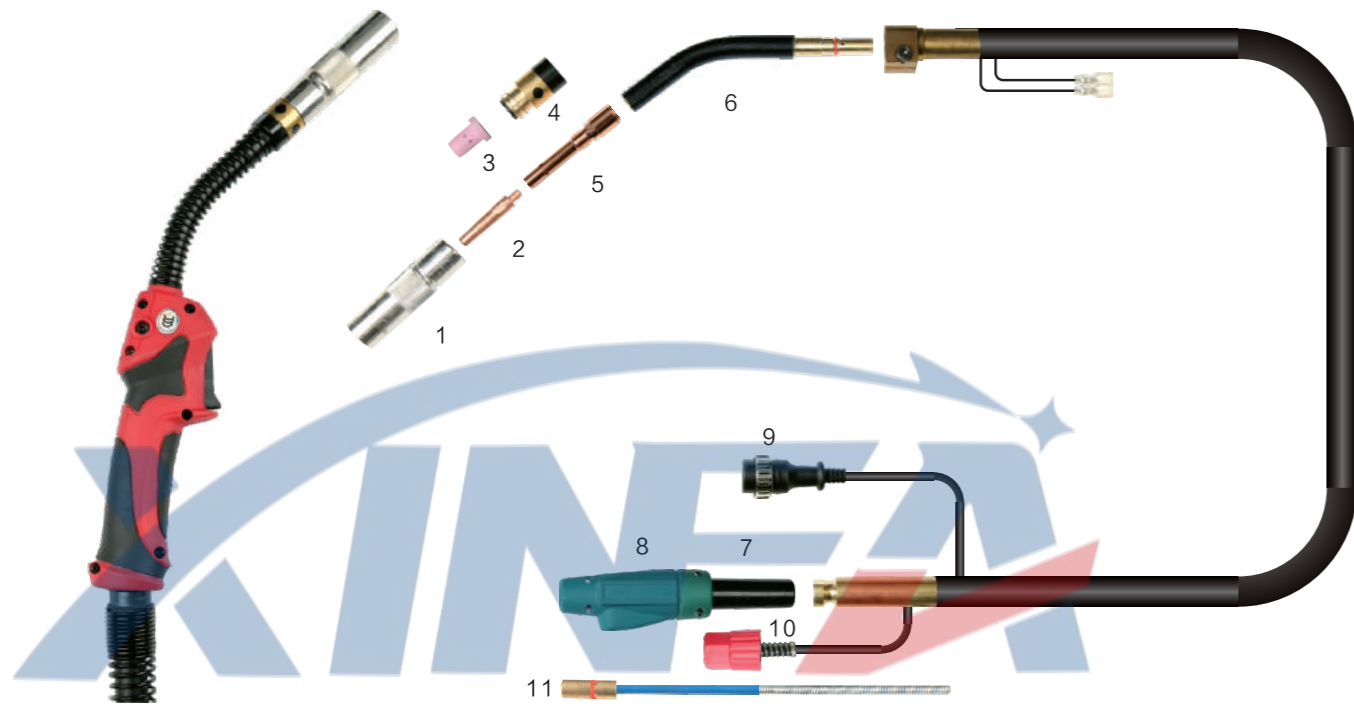

### Technical Data

Rating : 500A CO2  
350A Mixed Gases  
Duty cycle : 60%  
Wire size : 1.2-1.6mm

No.	Description
	500A Complete Torch 3M
	500A Complete Torch 5M
1	Cylindrical Nozzle $\phi$ 18.7mm
	Conical Nozzle $\phi$ 14mm
2	M6*45*1.0 Contact Tip,E-Cu
	M6*45*1.2 Contact Tip,E-Cu
	M6*45*1.6 Contact Tip,E-Cu
	M6*45*1.0 Contact Tip,CuCrZr
	M6*45*1.2 Contact Tip,CuCrZr
	M6*45*1.6 Contact Tip,CuCrZr
3	Gas Diffuser
4	Insulator
5	Contact Tip Holder

No.	Description
6	Swan Neck Separable
7	Black Cable Support Rubber
8	Rear Handle
9	Control Lead Plug
10	Nut 9/16-18 UNF
11	Liner,For Wire $\phi$ 1.2-1.6,3.5M
	Liner,For Wire $\phi$ 1.2-1.6,5.5M

### Wear Parts

$\phi$ A	Description
$\phi$ 20	Cylindrical Nozzle
$\phi$ 14	Conical Nozzle

Description
M6*45*1.0 Contact Tip,E-Cu
M6*45*1.2 Contact Tip,E-Cu
M6*45*1.6 Contact Tip,E-Cu
M6*45*1.0 Contact Tip,CuCrZr
M6*45*1.2 Contact Tip,CuCrZr
M6*45*1.6 Contact Tip,CuCrZr

Description
Gas Diffuser, Ceramic

Description
Insulator, Black
Insulator, Yellow

Description
Contact Tip Holder, Screw Outside
Contact Tip Holder,Screw Inside

  

Description
Separable Swan Neck

Description
Swan Neck

## Compatible Torch and Parts For Panasonic KH600A Water Cooled MIG/MAG Welding Torch

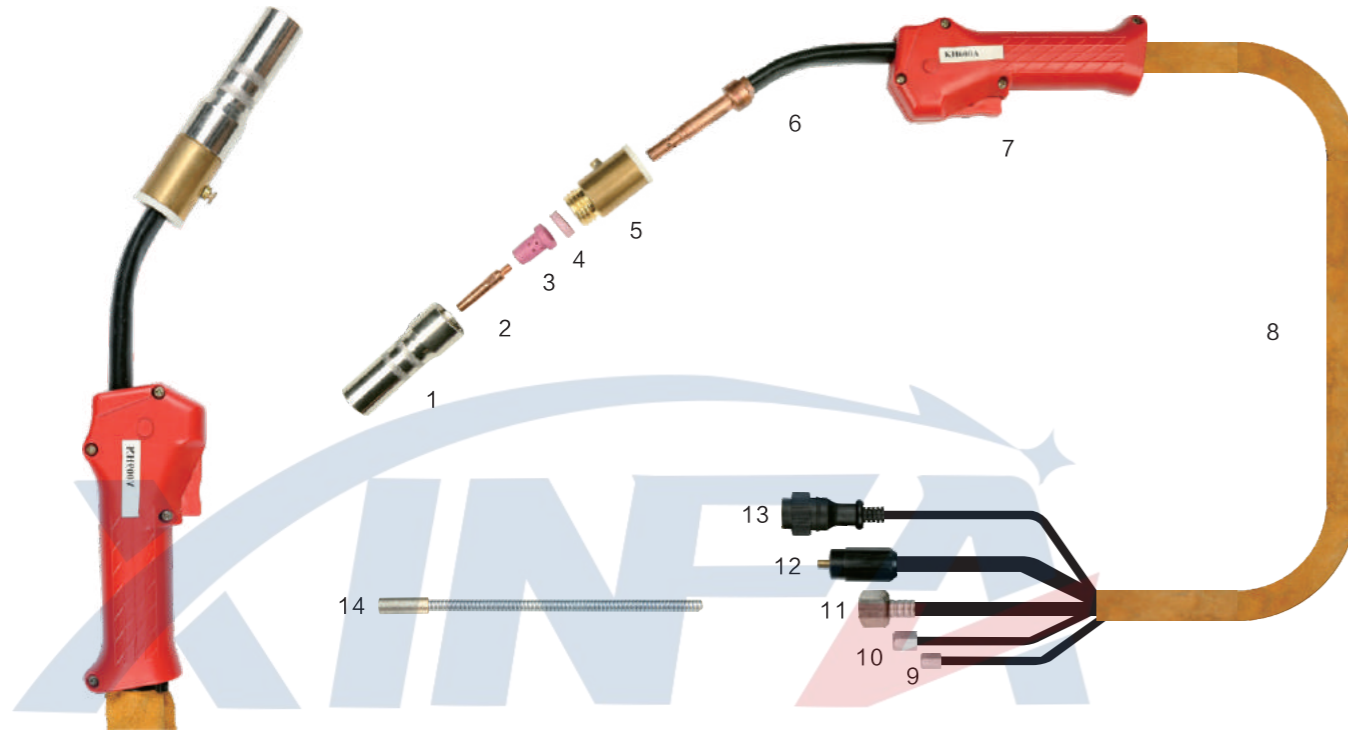

### Technical Data

Rating : 600A CO2  
550A Mixed Gases  
Duty cycle : 100%  
Wire size : 1.0-2.4mm

No.	Description
	KH600A Complete Torch 3M
	KH600A Complete Torch 5M
1	Nozzle $\phi$ 19mm
2	M6*45*1.0 Contact Tip,E-Cu
	M6*45*1.2 Contact Tip,E-Cu
	M6*45*1.6 Contact Tip,E-Cu
	M6*45*1.0 Contact Tip,CuCrZr
	M6*45*1.2 Contact Tip,CuCrZr
	M6*45*1.6 Contact Tip,CuCrZr
	M6*45*2.4 Contact Tip,CuCrZr
3	Gas Diffuser
4	Insulator
5	Water Insulator

No.	Description
6	Swan Neck
7	Front Handle
8	Leather Hose
9	Gas Inlet Connector
10	Water Inlet Connector
11	Cable Connector
12	Liner Connector
13	Control Plug
14	Liner,For Wire $\phi$ 1.0-1.2,3.5M
	Liner,For Wire $\phi$ 1.0-1.2,5.5M

### Wear Parts

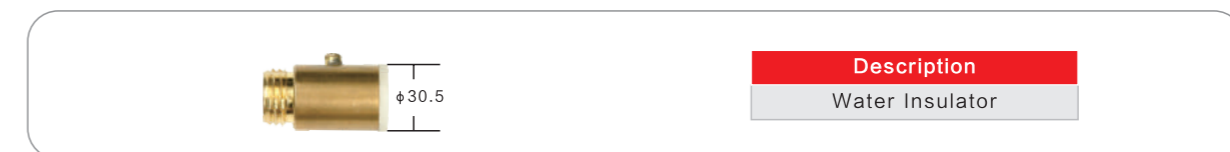
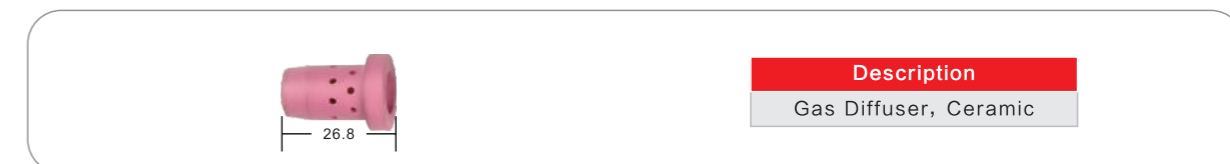
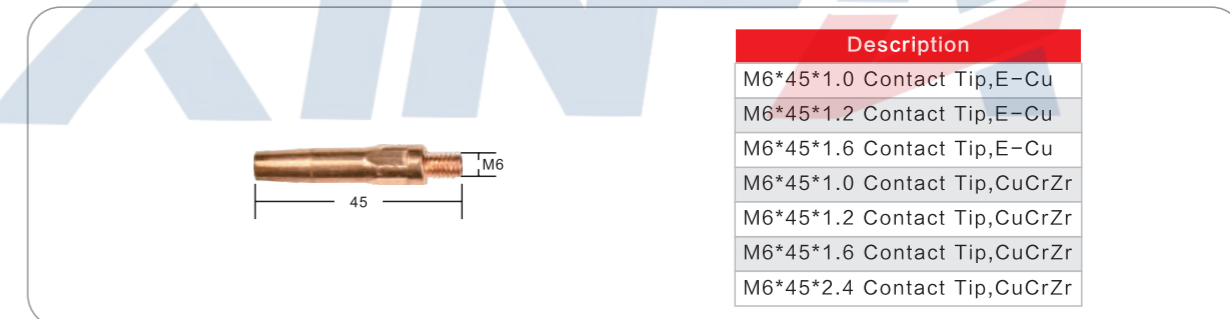
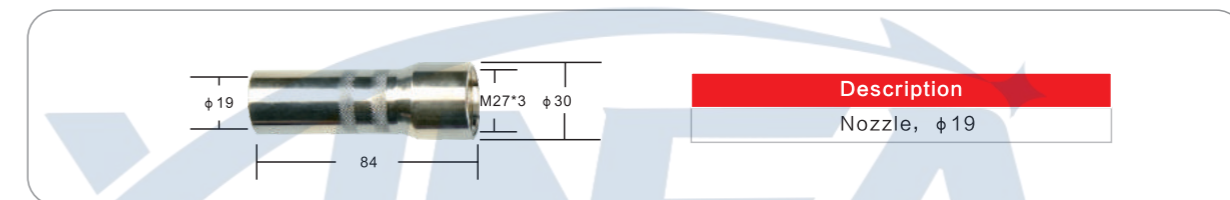

Our welding torches can adapt to various form handle, you are being able to make one's option according to self need

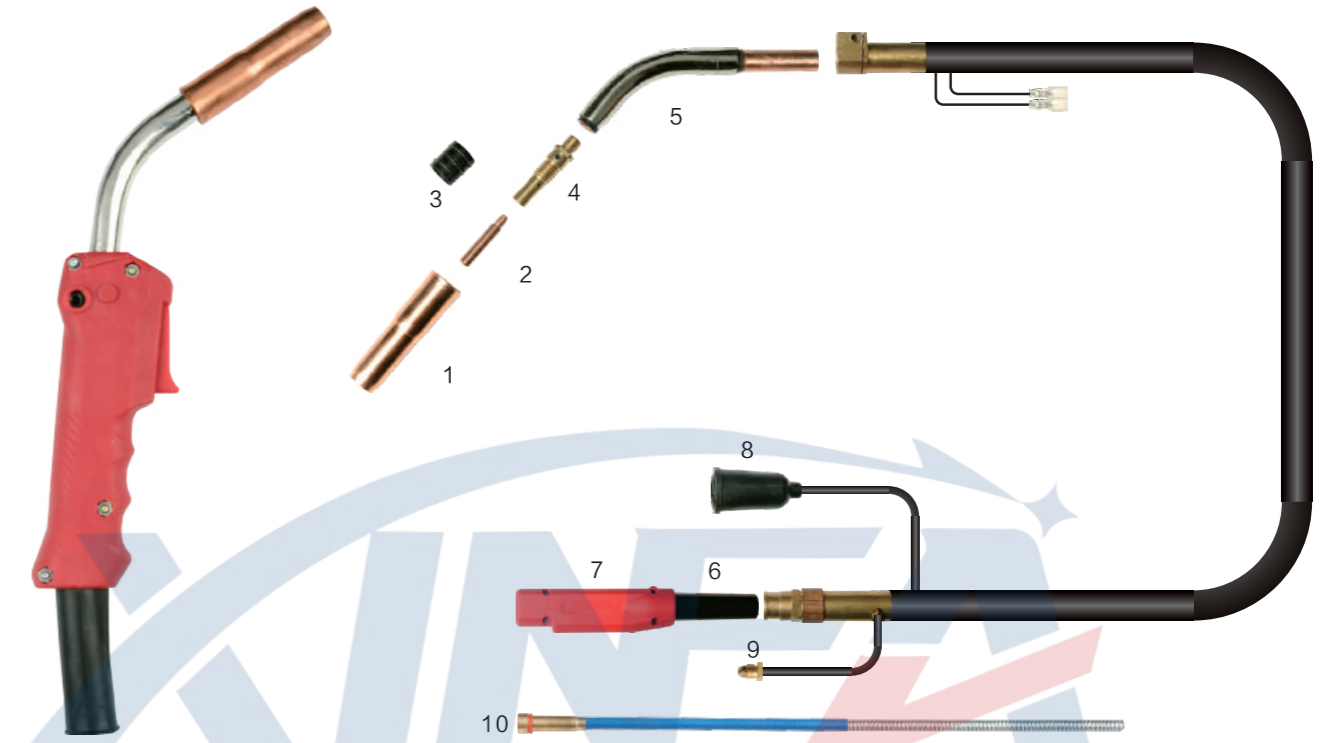

**Technical Data**

Rating : 350A CO2  
 300A Mixed Gases  
 Duty cycle : 60%  
 Wire size : 0.8-1.2mm

No.	Description
	Lincoln-1 Complete Torch 3M
	Lincoln-1 Complete Torch 5M
1	Nozzle
2	Contact Tip(0.8),CuCrZr
	Contact Tip(1.0),CuCrZr
	Contact Tip(1.2),CuCrZr
3	Insulator
4	Contact Tip Holder
5	Swan Neck
6	Black Cable Support Rubber
7	Rear Handle
8	Control Plug
9	Gas Inlet Connector

No.	Description
10	Liner,For Wire $\phi$ 0.8-1.0,3.5M
	Liner,For Wire $\phi$ 0.8-1.0,5.5M

### Wear Parts

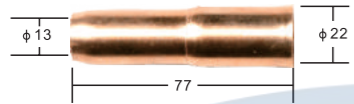

Description
Nozzle

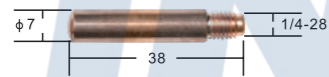

Description
Contact Tip(0.8),CuCrZr
Contact Tip(1.0),CuCrZr
Contact Tip(1.2),CuCrZr



Description
Insulator

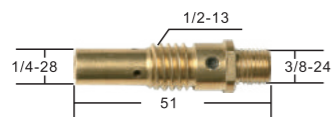

Description
Contact Tip Holder



Description
Swan Neck

## Compatible Torch and Parts For Lincoln Lincoln-2 Air Cooled MIG/MAG Welding Torch

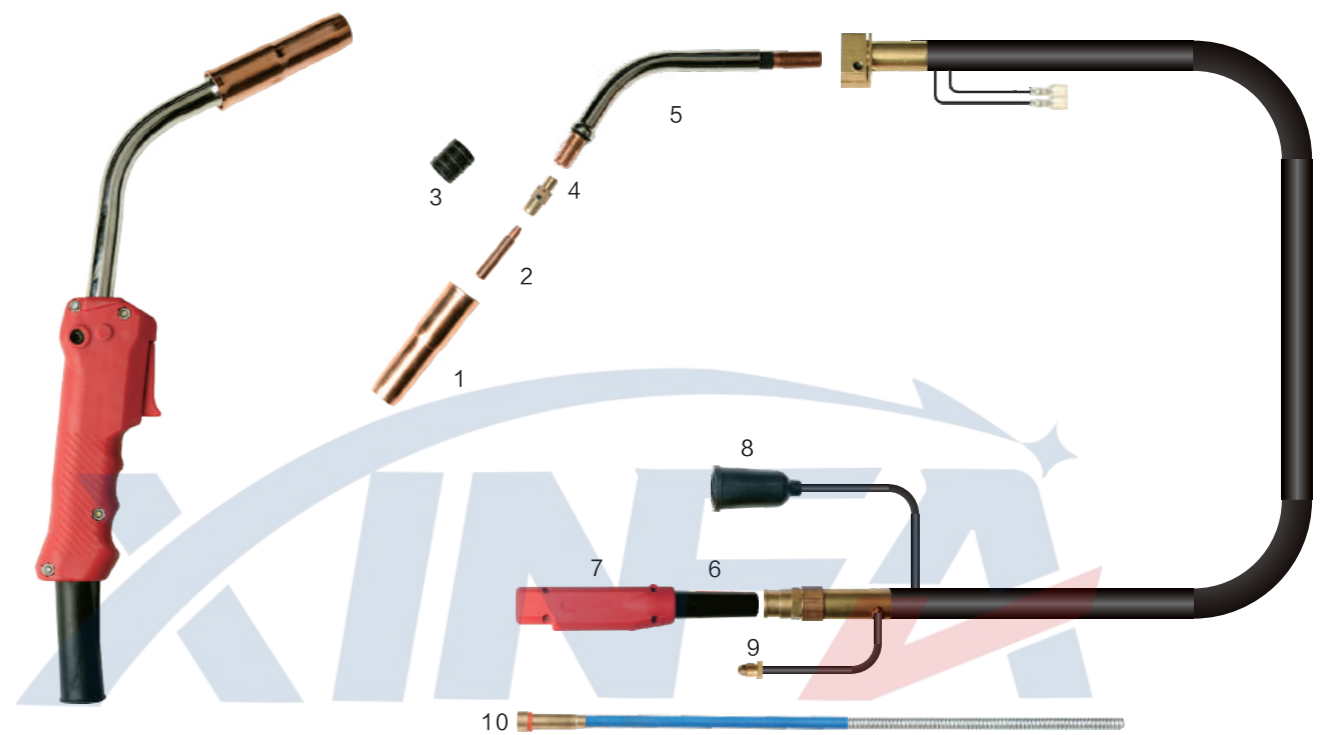

### Technical Data

Rating : 500A CO<sub>2</sub>  
350A Mixed Gases  
Duty cycle : 60%  
Wire size : 1.2-1.6mm

No.	Description
	Lincoln-2 Complete Torch 3M
	Lincoln-2 Complete Torch 5M
1	Nozzle
2	Contact Tip(1.2),CuCrZr
	Contact Tip(1.6),CuCrZr
3	Insulator
4	Contact Tip Holder
5	Swan Neck
6	Black Cable Support Rubber
7	Rear Handle
8	Control Plug
9	Gas Inlet Connector
10	Liner,For Wire $\phi$ 1.2-1.6,3.5M
	Liner,For Wire $\phi$ 1.2-1.6,5.5M





**Wear Parts**



Description
Nozzle

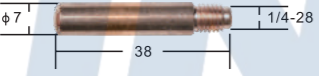

Description
Contact Tip(1.2),CuCrZr
Contact Tip(1.6),CuCrZr



Description
Insulator



Description
Contact Tip Holder

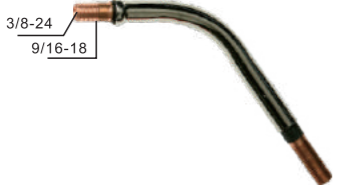

Description
Swan Neck

Compatible Torch and Parts For Lincoln  
Lincoln-3 Flux-cored Welding Torch



**Wear Parts**



Description
Flux Cored Contact Tip(2.0),CuCrZr



Description
Flux Cored Swan Neck 60°



Description
Flux Cored Swan Neck 90°

## Compatible Torch and Parts For ESAB PSF 250/305/405/505 Air Cooled MIG/MAG Welding Torch

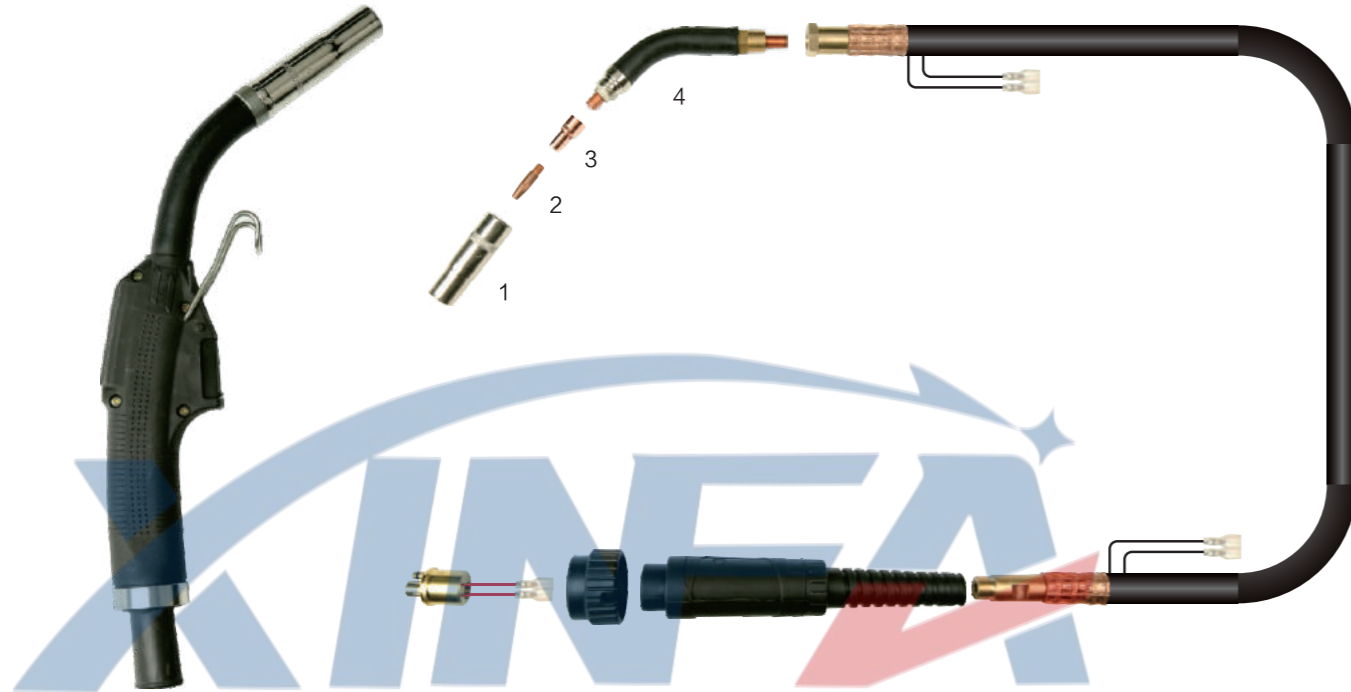

Nozzle	Description
	Nozzle PSF250
	Nozzle PSF305
	Nozzle PSF405
	Nozzle PSF505

Contact Tip	
Description	Description
M6*27*0.8 Contact Tip,E-Cu M6*27*0.8	M8*37*1.0 Contact Tip,E-Cu M8*37*1.0
M6*27*0.9 Contact Tip,E-Cu M6*27*0.9	M8*37*1.2 Contact Tip,E-Cu M8*37*1.2
M6*27*1.0 Contact Tip,E-Cu M6*27*1.0	M8*37*1.6 Contact Tip,E-Cu M8*37*1.6
M6*27*1.2 Contact Tip,E-Cu M6*27*1.2	M8*37*1.0 Contact Tip,CuCrZr M8*37*1.0
M6*27*0.8 Contact Tip,CuCrZr M6*27*0.8	M8*37*1.2 Contact Tip,CuCrZr M8*37*1.2
M6*27*1.0 Contact Tip,CuCrZr M6*27*1.0	M8*37*1.6 Contact Tip,CuCrZr M8*37*1.6
M6*27*1.2 Contact Tip,CuCrZr M6*27*1.2	M8*37*2.0 Contact Tip,CuCrZr M8*37*2.0
	M8*37*2.4 Contact Tip,CuCrZr M8*37*2.4

Contact Tip Holder	Description
	Contact Tip Holder PSF250
	Contact Tip Holder PSF305
	Contact Tip Holder PSF405
	Contact Tip Holder PSF505

Contact Tip	
	Swan Neck PSF250A
	Swan Neck PSF305
	Swan Neck PSF405
	Swan Neck PSF505

## Robot Welding torch



7W(7G) Robot Welding Torch For TBI

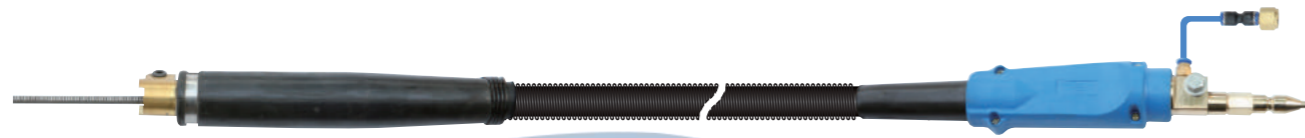

Robot Welding Torch For OTC



Anchuan Robot Welding Torch



Robot Welding Torch For Panasonic



Robot Welding Torch For South Korea

## Cleaning Torch Working Station



### Technical Data(技术参数)

working voltage	: 24V DC 15W
cutting wire diameter(剪丝直径)	: 1.6mm
insulation grade(绝缘等级)	: Ip21
enviroment tempreture(环境温度)	: +5℃~+50℃
gas inlet connector(进气接头)	: G1/8 6mm
working pressure(工作压力)	: 6-7bar
weight(重量)	: 20kg

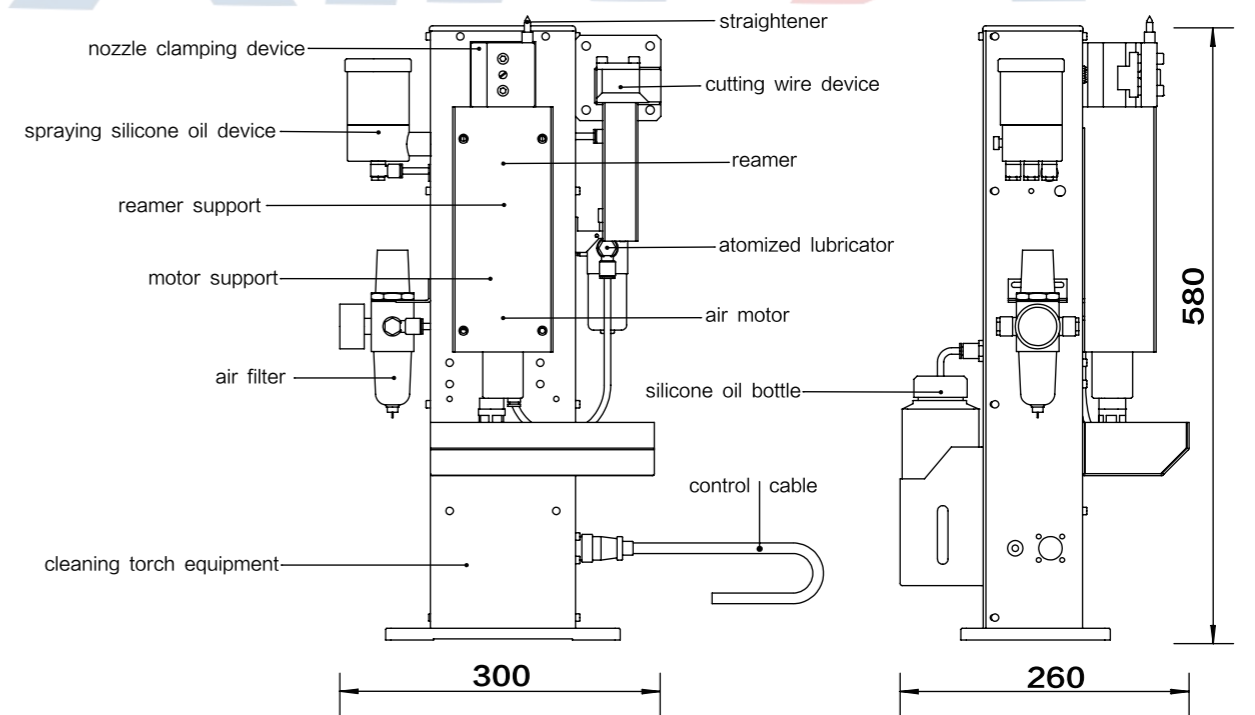

## WP-9 Air Cooled TIG Torch



No.	Description
1	WP-9 Air Cooled Torch Head
2	WP-9 Ceramic Nozzle
3	WP-9 Collet Body
4	WP-9 Collet
5	WP-9 Short Cap
6	WP-9 Long Cap

## WP-17 Air Cooled TIG Torch



No.	Description
1	WP-17 Air Cooled Torch Head
2	WP-17 Ceramic Nozzle 6#
3	WP-17 Ceramic Nozzle 7#
4	WP-17 Collet Body
5	WP-17 Collet
6	WP-17 Short Cap
7	WP-17 Long Cap

## WP-18 Water Cooled TIG Torch



No.	Description
1	WP-18 Air Cooled Torch Head
2	WP-18 Ceramic Nozzle 6#
3	WP-18 Ceramic Nozzle 7#
4	WP-18 Collet Body
5	WP-18 Collet
6	WP-18 Short Cap
7	WP-18 Long Cap

## WP-26 Air Cooled TIG Torch



No.	Description
1	WP-26 Air Cooled Torch Head
2	WP-26 Ceramic Nozzle 6#
3	WP-26 Ceramic Nozzle 7#
4	WP-26 Collet Body
5	WP-26 Collet
6	WP-26 Short Cap
7	WP-26 Long Cap

## QQ-150A TIG Torch

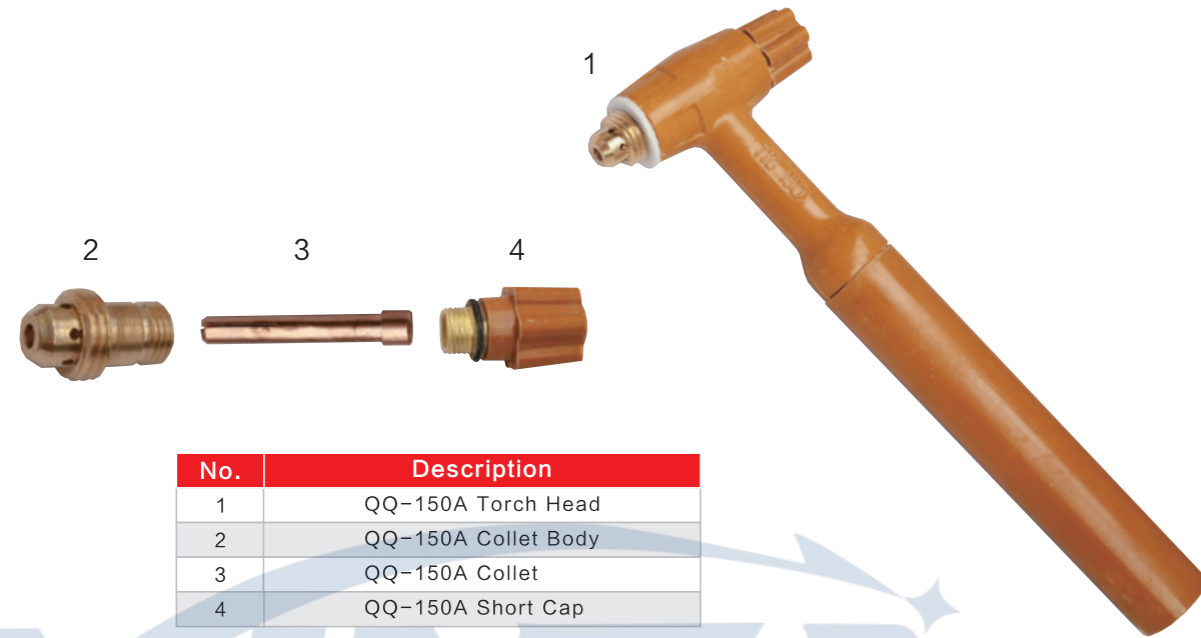

No.	Description
1	QQ-150A Torch Head
2	QQ-150A Collet Body
3	QQ-150A Collet
4	QQ-150A Short Cap

## QQ-300A TIG Torch

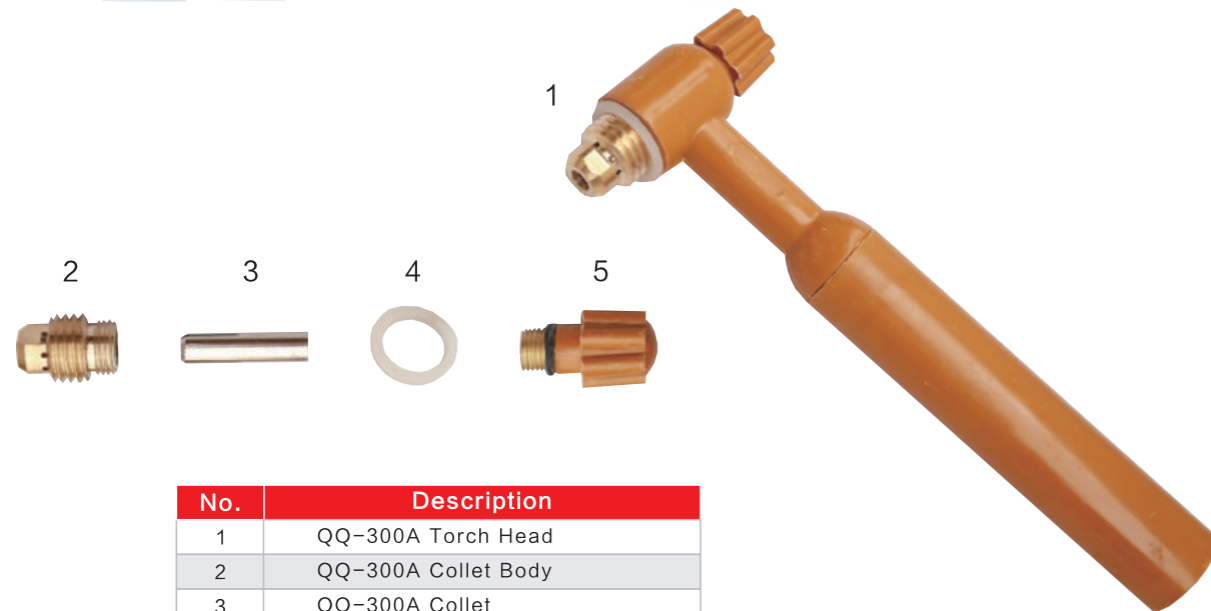

No.	Description
1	QQ-300A Torch Head
2	QQ-300A Collet Body
3	QQ-300A Collet
4	QQ-300A Heat Insulation Ring
5	QQ-300A Short Cap

## 7 Type Automatic Tig Torch

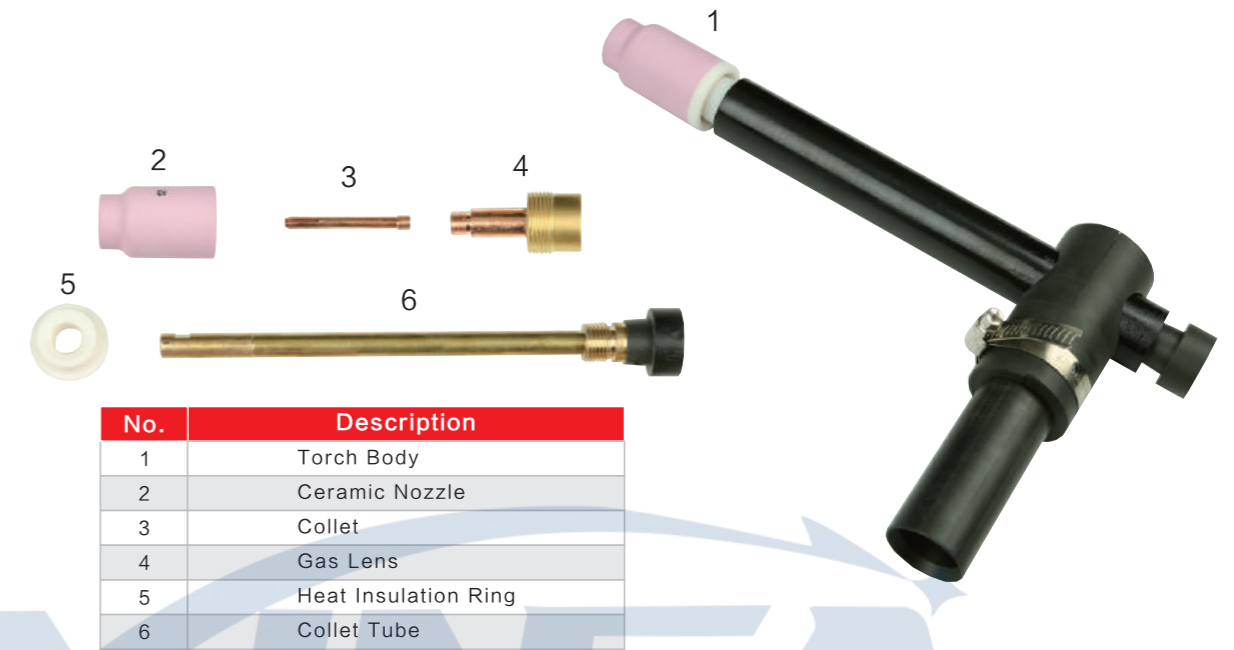

No.	Description
1	Torch Body
2	Ceramic Nozzle
3	Collet
4	Gas Lens
5	Heat Insulation Ring
6	Collet Tube

## AT 420/420S Automatic Tig Torch, Used For TBI

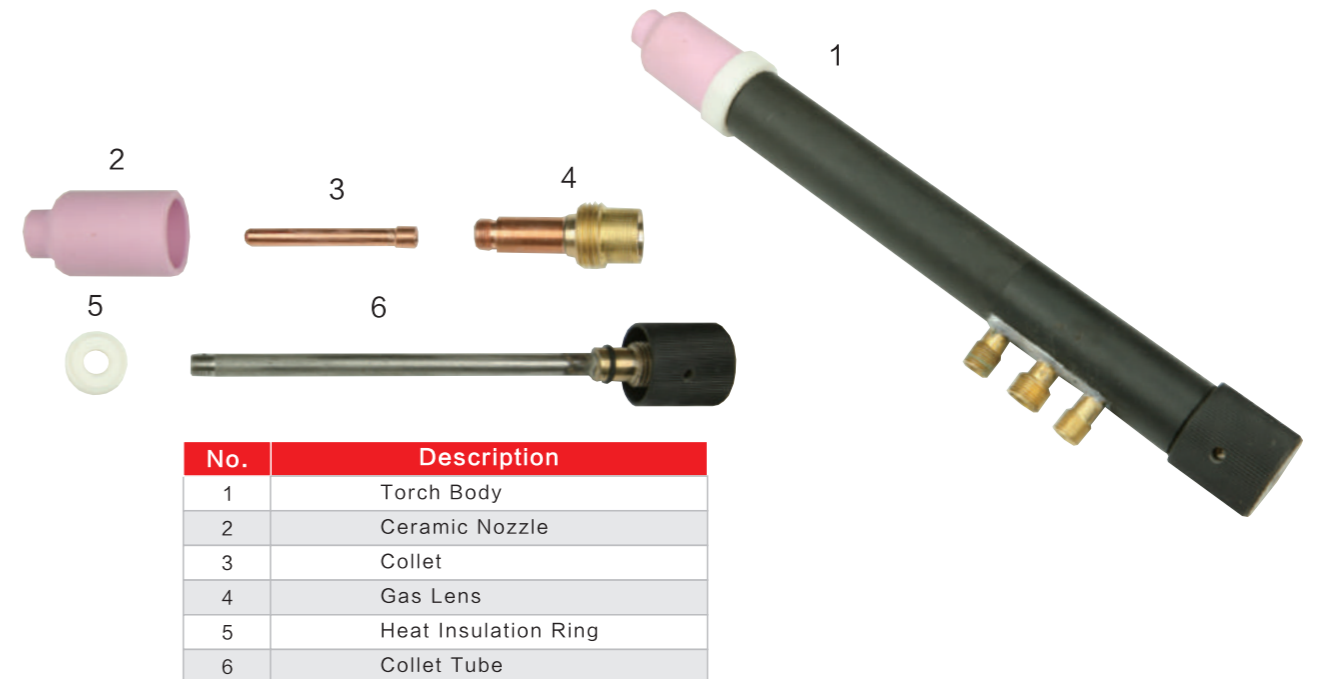

No.	Description
1	Torch Body
2	Ceramic Nozzle
3	Collet
4	Gas Lens
5	Heat Insulation Ring
6	Collet Tube

P-80 Air Cooled Plasma Cutting Torch

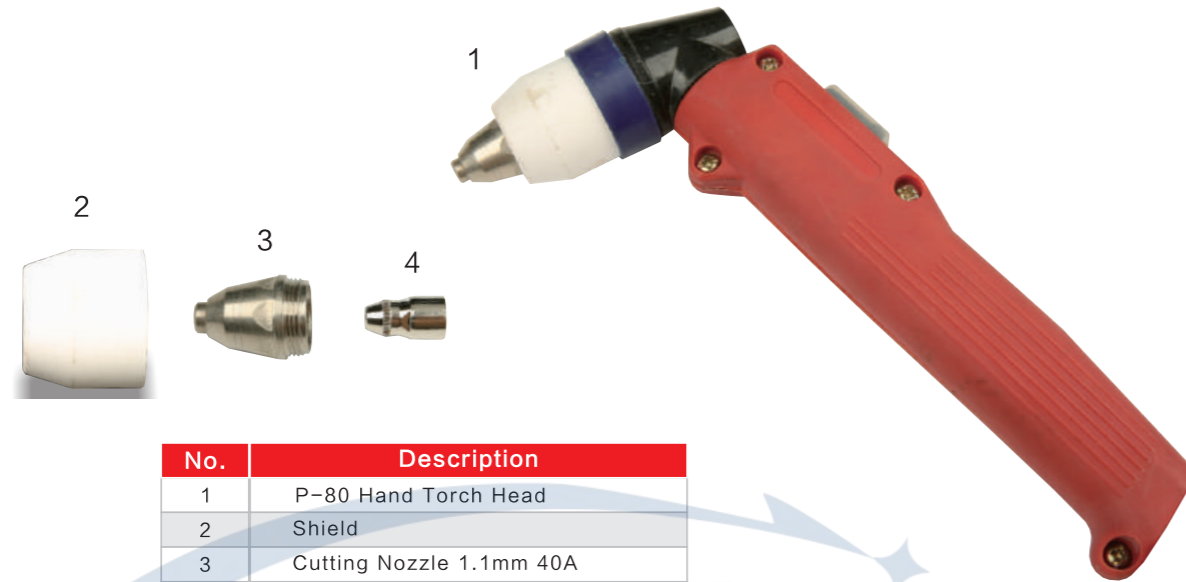

No.	Description
1	P-80 Hand Torch Head
2	Shield
3	Cutting Nozzle 1.1mm 40A
	Cutting Nozzle 1.1mm 60A
	Cutting Nozzle 1.5mm 80A
	Cutting Nozzle 1.7mm 100A
4	Electrode

PT-31 Air Cooled Plasma Cutting Torch

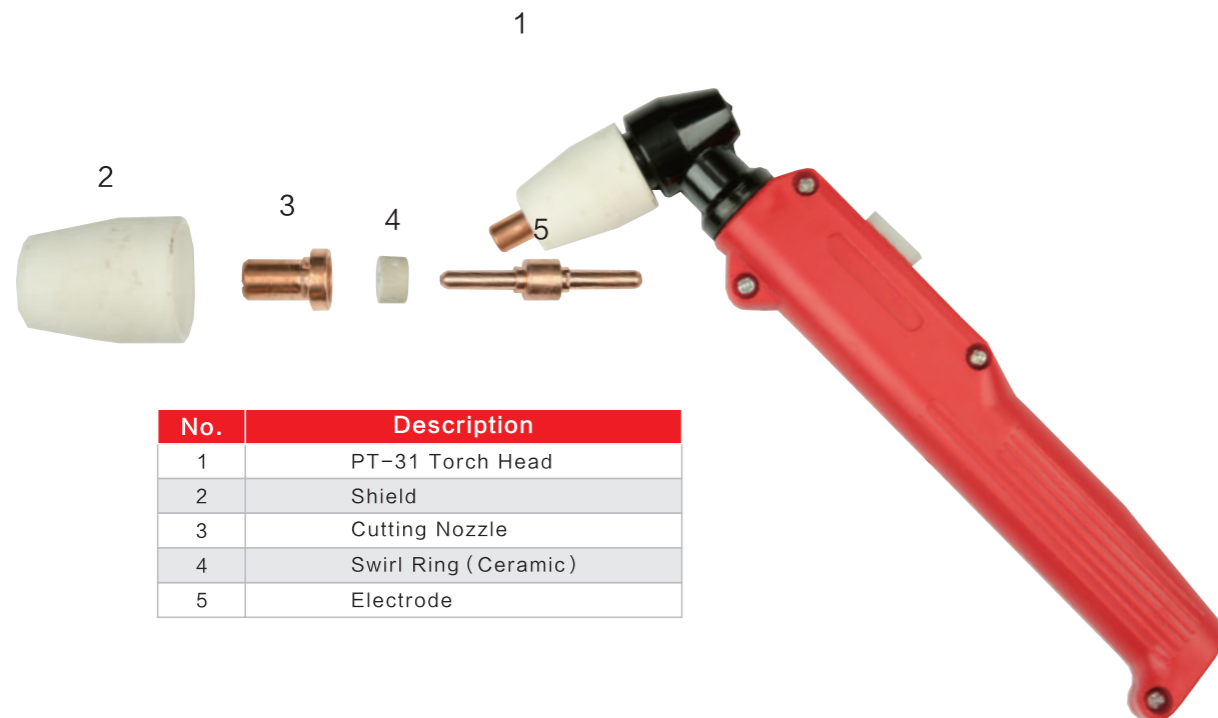

No.	Description
1	PT-31 Torch Head
2	Shield
3	Cutting Nozzle
4	Swirl Ring (Ceramic)
5	Electrode

A-81 Air Cooled Plasma Cutting Torch

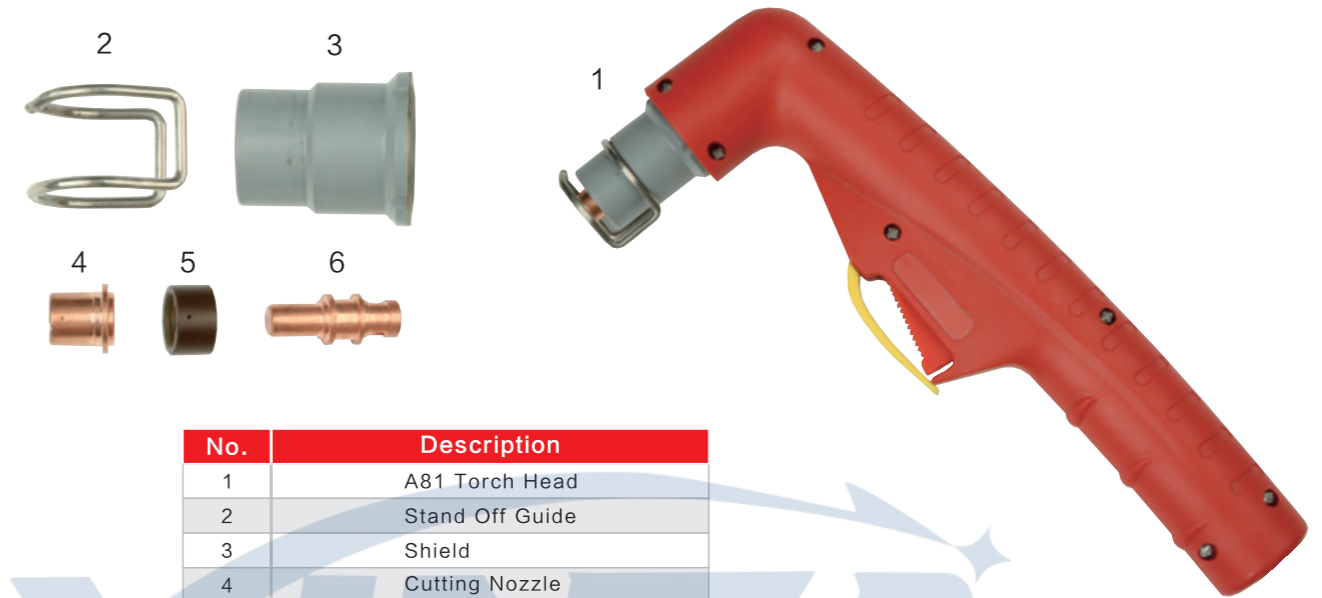

No.	Description
1	A81 Torch Head
2	Stand Off Guide
3	Shield
4	Cutting Nozzle
5	Swirl Ring
6	Electrode

CB-50 Air Cooled Plasma Cutting Torch

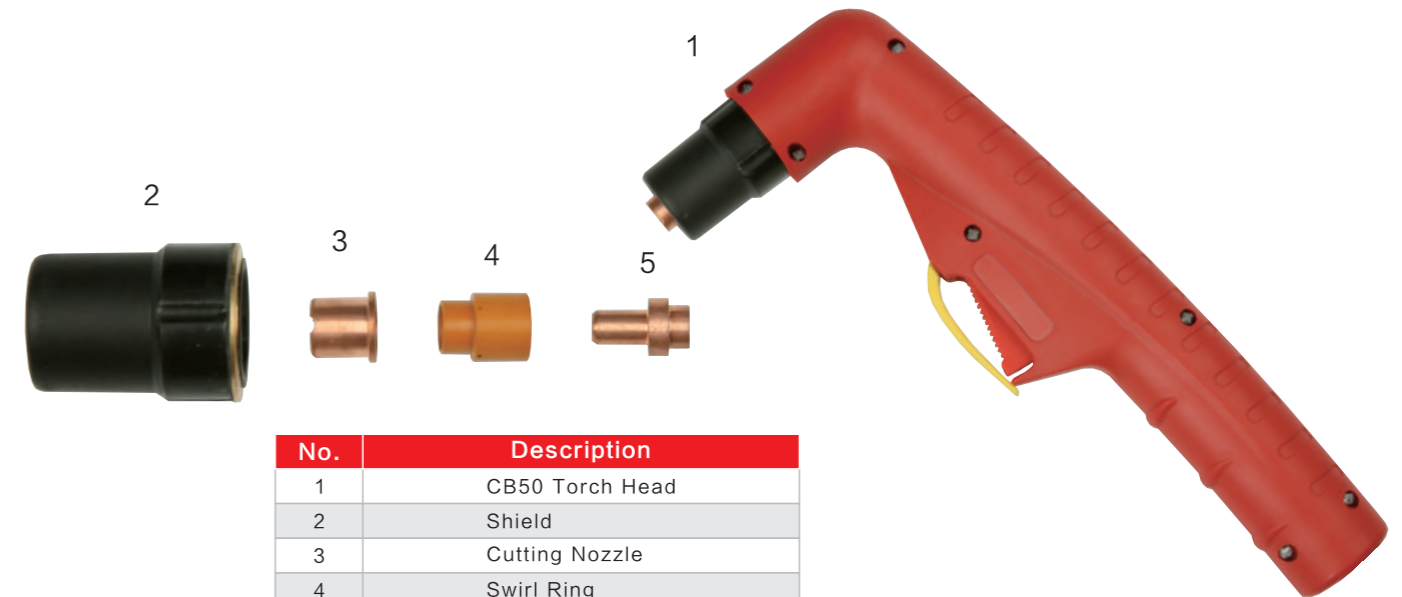

No.	Description
1	CB50 Torch Head
2	Shield
3	Cutting Nozzle
4	Swirl Ring
5	Electrode

## SP-60 Air Cooled Plasma Cutting Torch



## LT-50 Air Cooled Plasma Cutting Torch

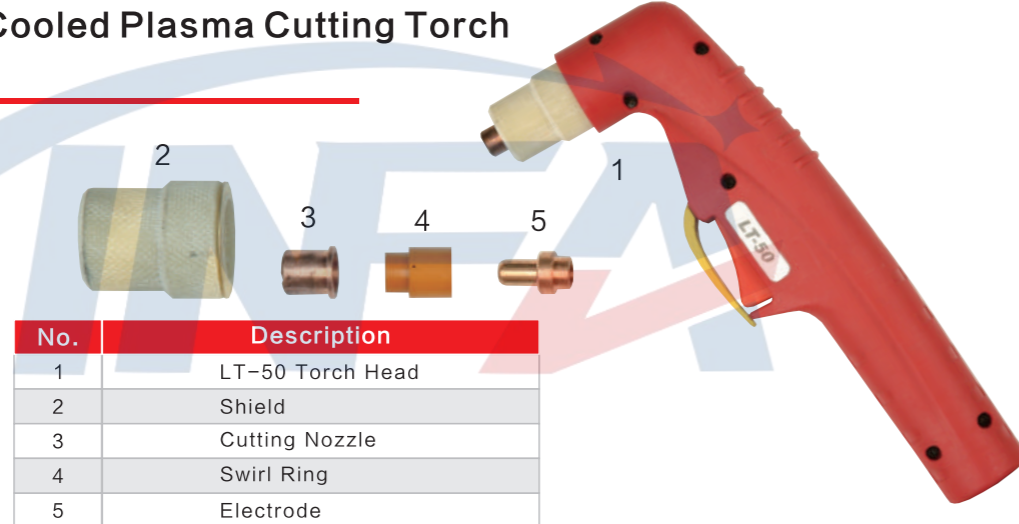

## TongChang60 Air Cooled Plasma Cutting Torch

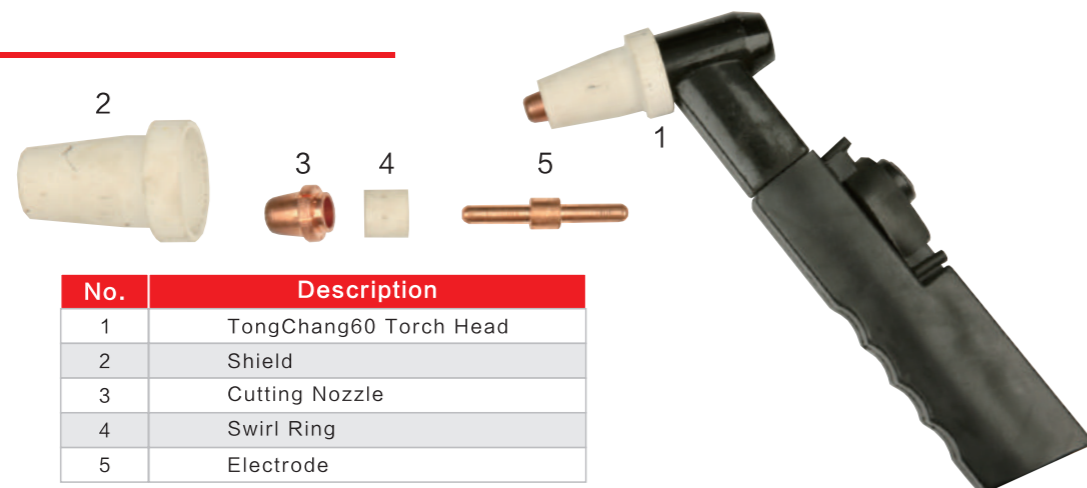

## Stud Welding Torch



## 200A Spool Gun

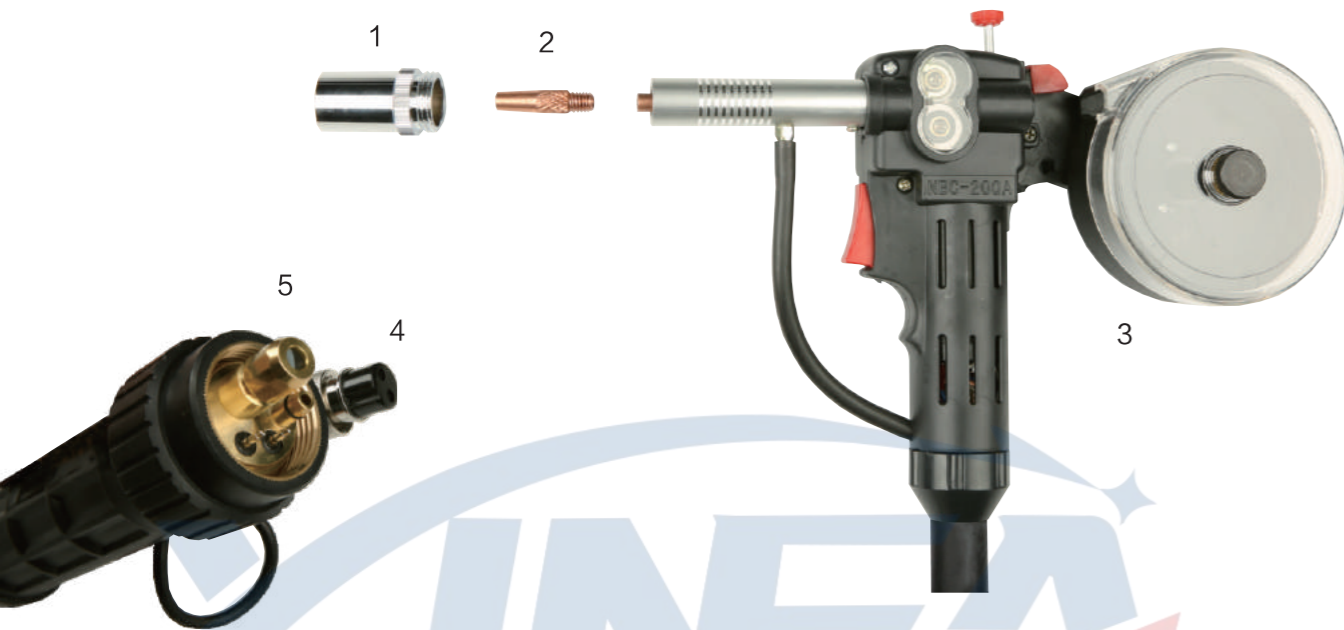

No.	Description
	200A Complete Torch 3M
	200A Complete Torch 5M
1	Spool Nozzle
2	Spool Tip
3	Wire Cover
4	Control Plug
5	Euro Connector

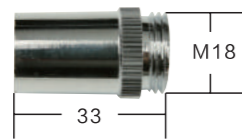

**Description**  
Spool Nozzle



**Description**  
Spool Tip

## Carbon Arc Gouging Torch

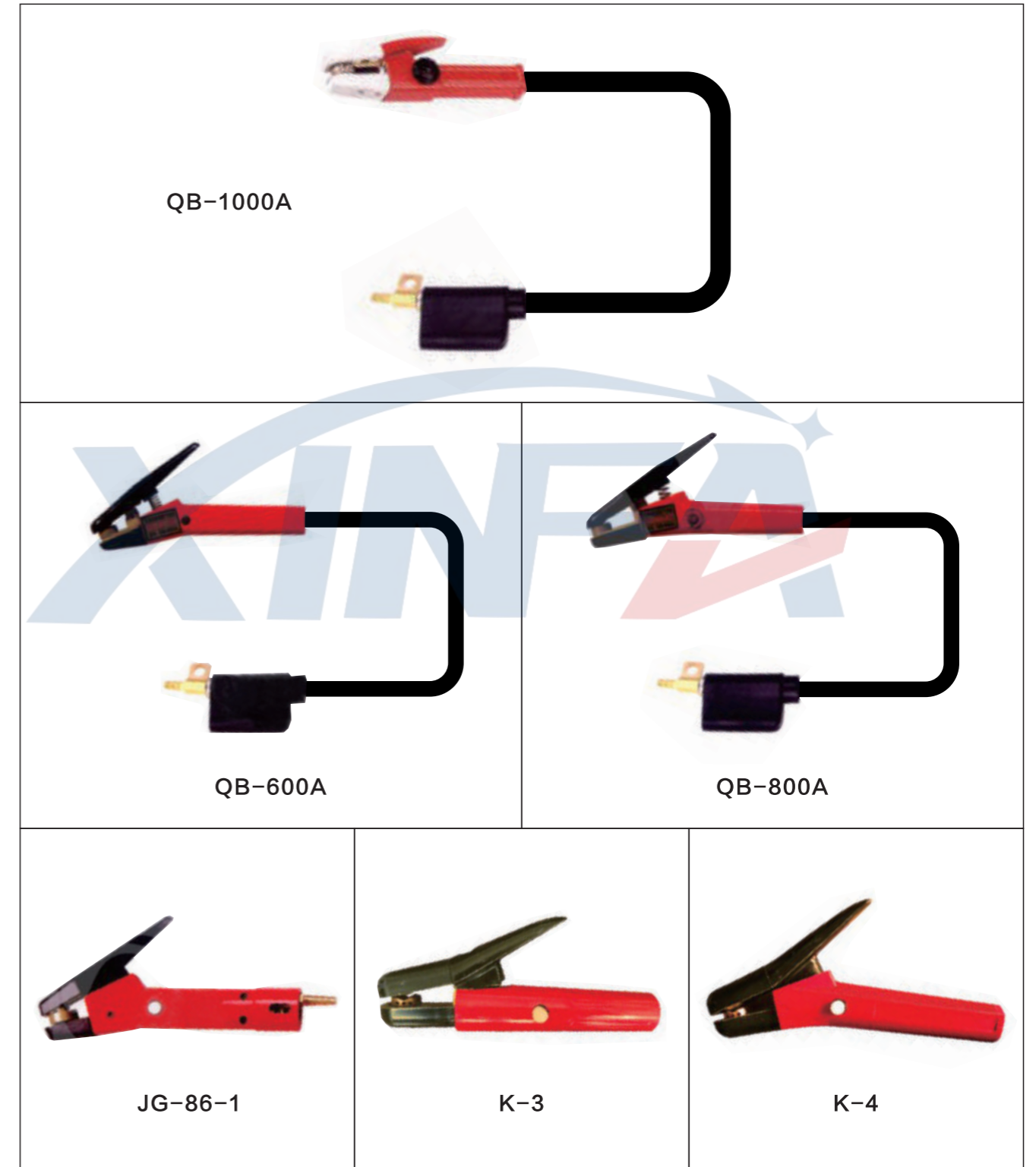

QB-1000A

QB-600A

QB-800A

JG-86-1

K-3

K-4





Description
M8*35*0.8 Contact Tip,CuCrZr
M8*35*0.9 Contact Tip,CuCrZr
M8*35*1.0 Contact Tip,CuCrZr
M8*35*1.2 Contact Tip,CuCrZr
M8*35*0.8 Contact Tip,CuCrZr For Al
M8*35*1.0 Contact Tip,CuCrZr For Al
M8*35*1.2 Contact Tip,CuCrZr For Al
M8*35*1.4 Contact Tip,CuCrZr For Al
M8*35*1.6 Contact Tip,CuCrZr For Al



Description
Nozzle

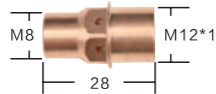

Description
Contact Tip Holder

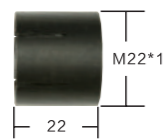

Description
Nozzle Retainer

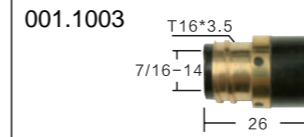

Insular,Use on 180A

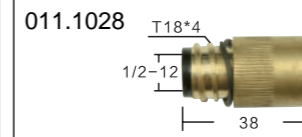

Insular,Use on 350A

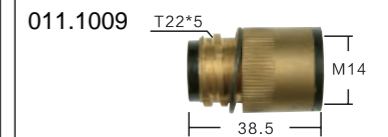

Insular,Use on 500A

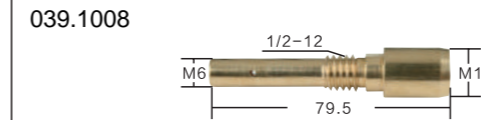

Contact Tip Holder,Use on 350A

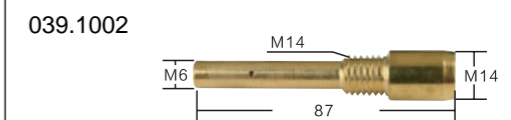

Contact Tip Holder,Use on 500A

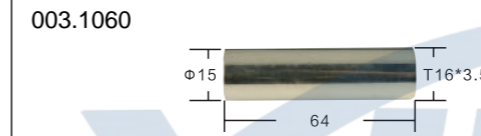

Nozzle,Use on 180A



Swan Neck Separable,Use on 350A

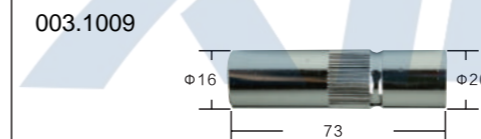

Nozzle,Use on 350A

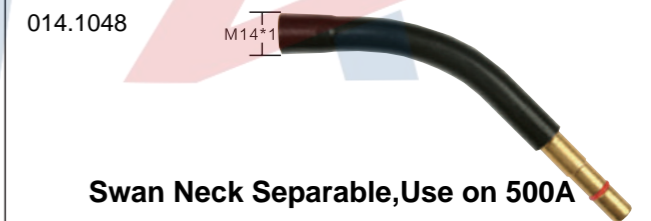

Swan Neck Separable,Use on 500A

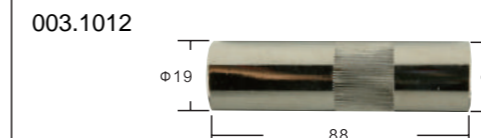

Nozzle,Use on 500A



Swan Neck ,Use on 180A



Swan Neck ,Use on 350A

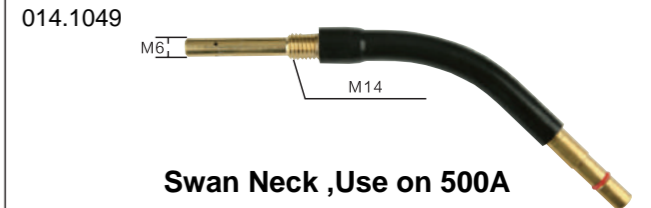

Swan Neck ,Use on 500A

## Compatible Parts For Miller

<p>003.1025</p> <p><b>Nozzle</b></p>	<p>039.1020</p> <p><b>Tip Holder</b></p>
<p>003.1034</p> <p><b>Nozzle</b></p>	<p>039.1009</p> <p><b>Tip Holder</b></p>
<p>003.1026</p> <p><b>Nozzle</b></p>	<p>039.1021</p> <p><b>Tip Holder</b></p>
<p>003.1030</p> <p><b>Nozzle</b></p>	<p>014.1007</p> <p><b>Swan Neck</b></p>
<p>004.1052</p> <p><b>Contact Tip</b></p>	<p>014.1050</p> <p><b>Swan Neck</b></p>
<p>004.1018</p> <p><b>Contact Tip</b></p>	<p>014.1026</p> <p><b>Swan Neck</b></p>

## Compatible Torch And Parts For Kemppi

<p>9003.015</p> <p><b>Nozzle</b></p>	<p>004.1009</p> <p><b>Contact Tip 0.8-1.0-1.2-1.6</b></p>	
<p>039.1015</p> <p><b>Tip Holder</b></p>	<p>014.1051</p> <p><b>Swan Neck</b></p>	
<p>003.1101</p> <p><b>Nozzle</b></p>	<p>004.1035</p> <p><b>Contact Tip 0.8-1.0-1.2-1.6</b></p>	
<p>039.1060</p> <p><b>Tip Holder</b></p>	<p>006.1002</p> <p><b>Gas Diffuser</b></p>	<p>014.1052</p> <p><b>Swan Neck</b></p>

We can provide any style connectors according to customers' requirement

<p><b>Compatible parts for Panasonic</b></p>	<p><b>Compatible parts for Binzel</b></p>
<p><b>Compatible parts for OTC</b></p>	<p><b>Compatible parts for Binzel 501D</b></p>
<p><b>Compatible parts for OTC</b></p>	<p><b>Compatible parts for ESAB</b></p>
<p><b>Compatible parts for Kemppi</b></p>	<p><b>Compatible parts for Miller</b></p>

<p>350A Wire Feeder for Panasonic</p>	<p>500A Wire Feeder for Panasonic</p>	<p>Wire Feeder for Euro style</p>	<p>Wire Feeder for South Korea</p>	<p>Wire Feeder Bracket</p>
<p>200A Wire Feeder Bracket for panasonic</p>	<p>350A Wire Feeder Bracket for panasonic</p>	<p>500A Wire Feeder Bracket for panasonic</p>	<p>500A Wire Feeder Bracket for panasonic</p>	<p>Wire Feeder Bracket for South Korea</p>
<p>Single Shaft Double Driven Bracket</p>	<p>Single Shaft Double Driven Bracket</p>	<p>Double Shaft Double Driven Bracket</p>	<p>Motor Assembly for Panasonic</p>	<p>PMDC Motor Assembly</p>
<p>Wire Reel Shaft for Panasonic</p>	<p>Reel Shaft for Panasonic</p>	<p>280 Reel Shaft</p>	<p>200 Remote Controller for OTC</p>	<p>OTC-CPVE350 Remote Controller</p>

350 Remote Controller for Panasonic	630 Remote Controller for Panasonic	Original Remote Controller for Panasonic	Digital Remote Controller for Panasonic	Inverter Remote Controller
Electromagnetil Valve 24V	Electromagnetil Valve for Panasonic	Pressure Arm for OTC	Pressure Arm for Panasonic	Outlet Tip for Wire Feeder
Handle for Panasonic	Handle for OTC	Connector for Panasonic to Euro style	Adaptor for OTC	Flange for Euro style
Plug for Euro style	Socket	Adaptor for Panasonic		

	SSL-01 Wire Feeder Roller 40*10*20, Comptible parts for Panasonic		SSL-02 Digital Wire Feeder Roller 42.5*8*16, Comptible parts for Panasonic
	SSL-03 Digital Wire Feeder Pressure Roller 40*8*16, Comptible parts for Panasonic		SSL-04 Wire Feeder Roller 42.5*10*18, Comptible parts for Panasonic
	SSL-05 Wire Feeder Roller 40*20*10, Comptible parts for OTC		SSL-06 Wire Feeder Roller 52*18*25, Comptible parts for OTC
	SSL-07 Wire Feeder Roller 30*22*10, Comptible parts for Binzel		SSL-08 Wire Feeder Roller 35*25*8, Comptible parts for Binzel
	SSL-09 Two Drive Wire Feeder Roller 36*10*11		SSL-10 Two Drive Wire Feeder Roller 40*10*12
	SSL-11 Wire Feeder Roller 42.5*22*14.3, Comptible parts for Miller		SSL-12 Wire Feeder Roller Gear 42.5*22*14.3, Comptible parts for Miller
	SSL-13 Wire Feeder Roller 43.8*16*7.1, Comptible parts for Lincoln		SSL-14 Wire Feeder Roller 44.5*28*13, Comptible parts for Lincoln
	SSL-15 Submerged Arc Welding Wire Feeder Roller 43.8*19*7.1, Comptible parts for Lincoln		SSL-16 Wire Feeder Roller 37*19*12, Comptible parts for Thermadyne
	SSL-17 Wire Feeder Roller 40*10*19, Comptible parts for Thermadyne		SSL-18 Driven Gear Feeder Roller 40*8*20, Comptible parts for Thermadyne

## Feeder Roller Series

 <p><b>SSL-19</b> Wire Feeder Roller 42.5*16*20, Comptible parts for Dadian</p>	 <p><b>SSL-20</b> Wire Feeder Roller 54*10*25, Comptible parts for Kemppi</p>
 <p><b>SSL-21</b> Two Drive Wire Feeder Roller 36*10*20, Comptible parts for Kemppi</p>	 <p><b>SSL-22</b> Wire Feeder Roller(Upper) 36*10*18, Comptible parts for Kemppi</p>
 <p><b>SSL-23</b> Wire Feeder Roller(Low) 36*10*18, Comptible parts for Kemppi</p>	 <p><b>SSL-24</b> Wire Feeder Roller 30*14*12, Comptible parts for SAF</p>
 <p><b>SSL-25</b> Wire Feeder Roller 40*16*35, Comptible parts for South Korea</p>	 <p><b>SSL-26</b> Wire Feeder Roller 34.5*10*20, Comptible parts for Fronius</p>
 <p><b>SSL-27</b> Wire Feeder Roller 47*10*17,Zinc Spray</p>	 <p><b>SSL-28</b> Wire Feeder Roller 30*10*18, Comptible parts for Esab</p>
 <p><b>SSL-29</b> Submerged Arc Welding Wire Feeder Roller 50*16*20, Comptible parts for Esab</p>	 <p><b>SSL-30</b> Wire Feeder Roller 40*19*12, Comptible parts for Cloos</p>
 <p><b>SSL-31</b> Wire Feeder Roller 41*8*19, Comptible parts for Cloos</p>	 <p><b>SSL-32</b> Wire Feeder Roller 33*8*18, Comptible parts for Anchuan 5 Generation</p>
 <p><b>SSL-33</b> Wire Feeder Roller 30*14*12, Comptible parts for Anchuan</p>	 <p><b>SSL-34</b> Wire Feeder Roller K Groove 30*14*12, Comptible parts for Anchuan</p>
 <p><b>SSL-35</b> Wire Feeder Roller 33*10*19, Comptible parts for Anchuan</p>	 <p><b>SSL-36</b> Submerged Arc Welding Wire Feeder Roller 40*14*12, Comptible parts for Zhenkang</p>

## Feeder Roller Series

 <p><b>SSL-37</b> Submerged Arc Welding Wire Feeder Roller 44*14*14, Comptible parts for Zhenkang</p>	 <p><b>SSL-38</b> Submerged Arc Welding Wire Feeder Roller 44*17*18.5, Comptible parts for Zhenkang</p>
 <p><b>SSL-39</b> Wire Feeder Roller 37*19*12, Comptible parts for Rem</p>	 <p><b>SSL-40</b> Wire Feeder Roller 44*10*18</p>
 <p><b>SSL-41</b> Wire Feeder Roller 40*32*10</p>	 <p><b>SSL-42</b> Wire Feeder Roller 41.5*25.5*14.2, Comptible parts for Haobot</p>
 <p><b>SSL-43</b> Wire Feeder Roller 29.5*8*18</p>	 <p><b>SSL-44</b> Automatic Welding Wire Feeder Roller 30*12*13</p>
 <p><b>SSL-45</b> Wire Feeder Roller 37*12*16.5</p>	 <p><b>SSL-46</b> Wire Feeder Roller 41.5*12*10</p>
 <p><b>SSL-47</b> Wire Feeder Roller 38*10*20, Comptible parts for Migatronic</p>	 <p><b>SSL-48</b> Submerged Arc Welding Wire Feeder Roller 44*24*8</p>
 <p><b>SSL-49</b> Wire Feeder Roller 40*28*10</p>	 <p><b>SSL-50</b> Wire Feeder Roller 44*9*13</p>
 <p><b>SSL-51</b> Wire Feeder Roller 29*9.7*12, Comptible parts for Boc</p>	 <p><b>SSL-52</b> Wire Feeder Roller 38*23*16</p>
 <p><b>SSL-53</b> Wire Feeder Roller 29*9.7*12</p>	 <p><b>SSL-54</b> Butter Wire Feeder Roller 30*14*14</p>

## Liner

Compatible Parts For European Style	
	Liner, For wire $\Phi 0.8-1.0-1.2-1.6, 3.5M$ Liner, For wire $\Phi 0.8-1.0-1.2-1.6, 5.5M$
Compatible Parts For Binzel	
	Liner, For wire $\Phi 0.8-1.0-1.2-1.6, 3.5M$ Liner, For wire $\Phi 0.8-1.0-1.2-1.6, 5.5M$
Compatible Parts For Panasonic	
	Liner, For wire $\Phi 0.8-1.0-1.2-1.6, 3.5M$ Liner, For wire $\Phi 0.8-1.0-1.2-1.6, 5.5M$
Compatible Parts For OTC	
	Liner, For wire $\Phi 0.8-1.0-1.2-1.6, 3.5M$ Liner, For wire $\Phi 0.8-1.0-1.2-1.6, 5.5M$
Compatible Parts For Lincoln	
	Liner, For wire $\Phi 0.8-1.0-1.2-1.6, 3.5M$ Liner, For wire $\Phi 0.8-1.0-1.2-1.6, 5.5M$

## Liner

Compatible Parts For Miller	
	Liner, For wire $\Phi 0.8-1.0-1.2-1.6, 3.5M$ Liner, For wire $\Phi 0.8-1.0-1.2-1.6, 5.5M$
Compatible Parts For Kemppi	
	Liner, For wire $\Phi 0.8-1.0-1.2-1.6, 3.5M$ Liner, For wire $\Phi 0.8-1.0-1.2-1.6, 5.5M$
Compatible Parts For ESAB	
	Liner, For wire $\Phi 0.8-1.0-1.2-1.6, 3.5M$ Liner, For wire $\Phi 0.8-1.0-1.2-1.6, 5.5M$
Teflon Liners	
	Blue Liner 1.5/4.0, For wire $\Phi 0.8-1.0, 3M$
	Blue Liner 1.5/4.0, For wire $\Phi 0.8-1.0, 5M$
	Red Liner 2.0/4.0, For wire $\Phi 1.0-1.2, 3M$
	Red Liner 2.0/4.0, For wire $\Phi 1.0-1.2, 5M$
	Yellow Liner 2.7/4.7, For wire $\Phi 1.6, 3M$ Yellow Liner 2.7/4.7, For wire $\Phi 1.6, 5M$
Welding Liner (For Aluminium)	
	Welding Liner 2.0/4.0, 3M Welding Liner 2.7/4.7, 5M

## Submerged Arc Welding Liner

We can provide various specification liners according to customer's need

Robot Welding Liner, Used For Panasonic



OTC Robot Welding Liner, Used For OTC



SSG-01



SSG-02



SSG-03



SSG-04



SSG-05



SSG-06



## Submerged Arc Welding Liner

We can provide various specification liners according to customer's need



SSG-07

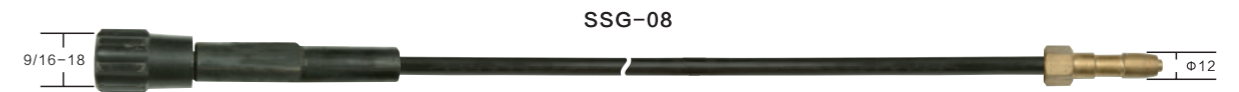

SSG-08



SSG-09



SSG-10



SSG-11



SSG-12



SSG-13



SSG-14

## Control Wire Plugs

CT-01  2 pins plug	CT-02  3 pins plug	CT-03  4 pins plug	CT-04  5 pins plug
CT-05  7 pins plug	CT-06  10 pins plug(non standard)	CT-07  14 pins plug	CT-08  17 pins plug
CT-09  19 pins plug	CT-10  4 pins plug	CT-11  6 pins plug	CT-12  10 pins plug
CT-13  5 pins plug( big needle)	CT-14  4 pins socket	CT-15  6 pins socket	CT-16  7 pins socket
CT-17  10 pins socket	CT-18  14 pins socket	CT-19  6 pins plug(non standard)	CT-20  3 pins plug(flat)

## Control Wire Plugs









CT-21  5 pins plug(flat)	CT-22  2 pins plug	CT-23  3 pins plug	CT-24  plug(10 pins)socket
CT-25  5 pins plug for Lincoln	CT-26  plug for Lincoln	CT-27  plug for Lincoln	CT-28  plug for Miller
CT-29  plug for Miller	CT-30  plug for Miller	CT-31  pins plug(flat)	CT-32  socket(2 pins) plug 2 pins with wire
CT-33  socket (4 pins) plug	CT-34  socket(4 pins lengthen)plug	CT-35  socket(6 pins)plug	CT-36  isomerism(6 pins)
CT-37  socket(6 pins lengthen)plug	CT-38  socket(7 pins)plug	CT-39  socket(9 pins)plug	CT-40  socket(9 pins lengthen)plug



## All Kinds Of Parts

			
Dust Prevent Cover	Dust Prevent Cover	Dust Prevent Cover Compatible Parts For Lincoln	Wire Spool
			
Barreled Wire Cover 350KG	Barreled Wire Cover 250KG	Cantalever Master Cable	Cantalever Hypotaxis Cable
			
Rubber Hose	Canverse Hose	Leather Hose	Welding Tip Stuff Protective Paste
			
CO <sub>2</sub> Flowmeter	Welding Smoke Suction	Wire Column	Wire Column, Compatible Parts For Lincoln
			
Wire Column, Compatible Parts For Panasonic	Wire Column 200A	Holland Type Earth Clamp	Holland Type Electrode Holder
	Cable Connector		

## Car Special Spot Welding Electrode And Accessories

	Electrode Series
	Electrode Cap Series
	Electrode Holder Series
	Electrode Stem Series
	Straight Electrode Series
	Positioning Bolt And Nut Electrode Series
	Electrode Arm Series
	Other Accessories
Balancer	
Localizer	
Structural Adhesive	
Spot Welding Adhesive	
Soft Conjunction	